

Easy to monitor and ready for IoT



This series redefines safety at manufacturing sites

Manufacturers now need to manage globalization and flexible production. That's why we have developed our F3SG-SR/PG Series. This series offers a complete lineup of light curtains that comply with global safety standards and a wide range of functionality that covers all aspects from design through to maintenance. The F3SG-SR/PG Series helps manufacturers build safety systems.



Build flexible safety systems

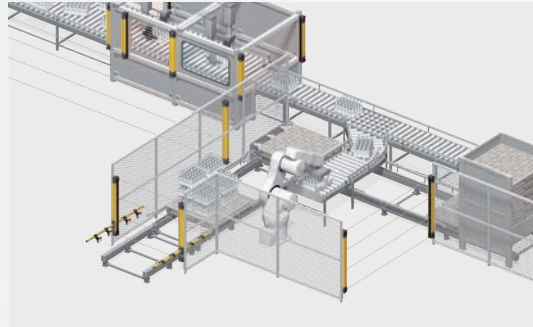

Design

- Easy design of line safety Page 4
- Flexible design for equipment Page 8

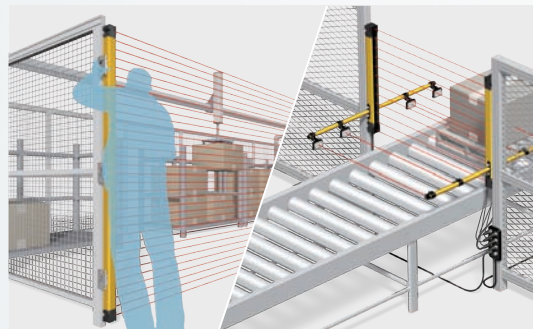

Set-up

- Simple beam adjustment Page 10
- Easy installation and angle adjustment Page 11
- Various options to reduce wiring Page 12



Operation

- Reduction in unwanted machine stoppages Page 14



Maintenance

- Maintenance with no special skills required Page 16
- Quick maintenance through ICT Page 17

One series covers all protection applications—from machine

Standardize mechanical design across production lines and eliminate complexity of selection and design.

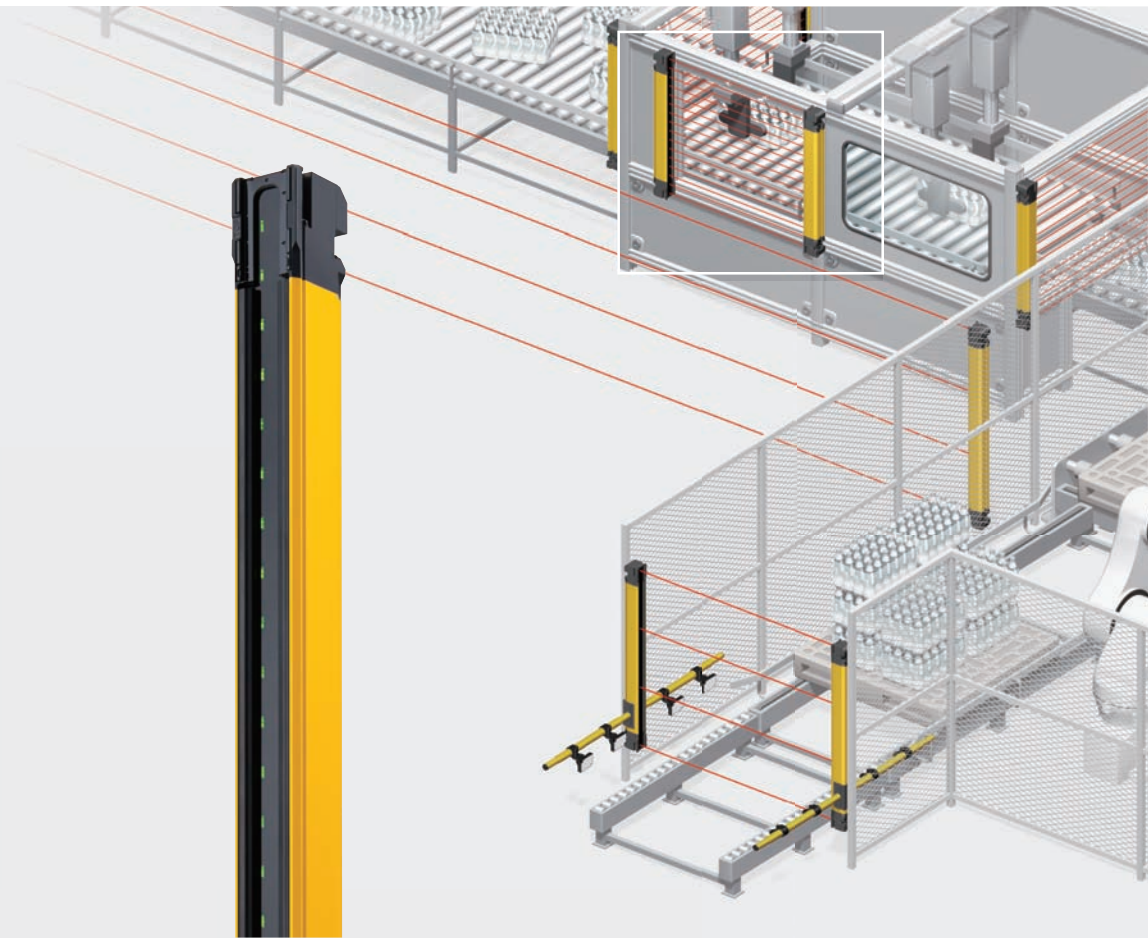

Protection at machine openings

Safety Light Curtain F3SG-SR

Finger Protection

Beam gap	10 mm	Detection capability 14-mm dia.
Protective height	160 to 2,000 mm	
Max. operating range Min./Typ.	10 m / 15 m	

IP69K model available

Hand Protection

Beam gap	20 mm	Detection capability 25-mm dia.
Protective height	160 to 2,480 mm	
Max. operating range Min./Typ.	20 m / 30 m	

IP69K model available

Arm/Leg Protection

Beam gap	40 mm	Detection capability 45-mm dia.
Protective height	240 to 1,520 mm	
Max. operating range Min./Typ.	20 m / 30 m	

Body Protection

Beam gap	80 mm	Detection capability 85-mm dia.
Protective height	280 to 920 mm	
Max. operating range Min./Typ.	20 m / 30 m	

Common optional accessories including cables and brackets*

The light curtains share common optional accessories for ease of design and retrofitting of production lines.

Intelligent Tap
F39-SGIT-IL3

Bluetooth® Communication Unit
F39-SGBT



Lamp
F39-SGLP



Muting Sensor Arm Mounter
F39-FMA



Muting Sensor Connection Box
F39-GCN5



Floor Mount Column
F39-ST

Mount-Column Adjustable Base
F39-STB

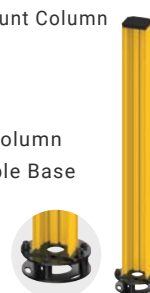

Mirror Column (for F3SG-SR Safety Light Curtain)
F39-SML



* Except for some optional accessories. See the F3SG-SR/PG Datasheet for details.

(The mount-column adjustable base is sold separately.)

openings to perimeters of equipment

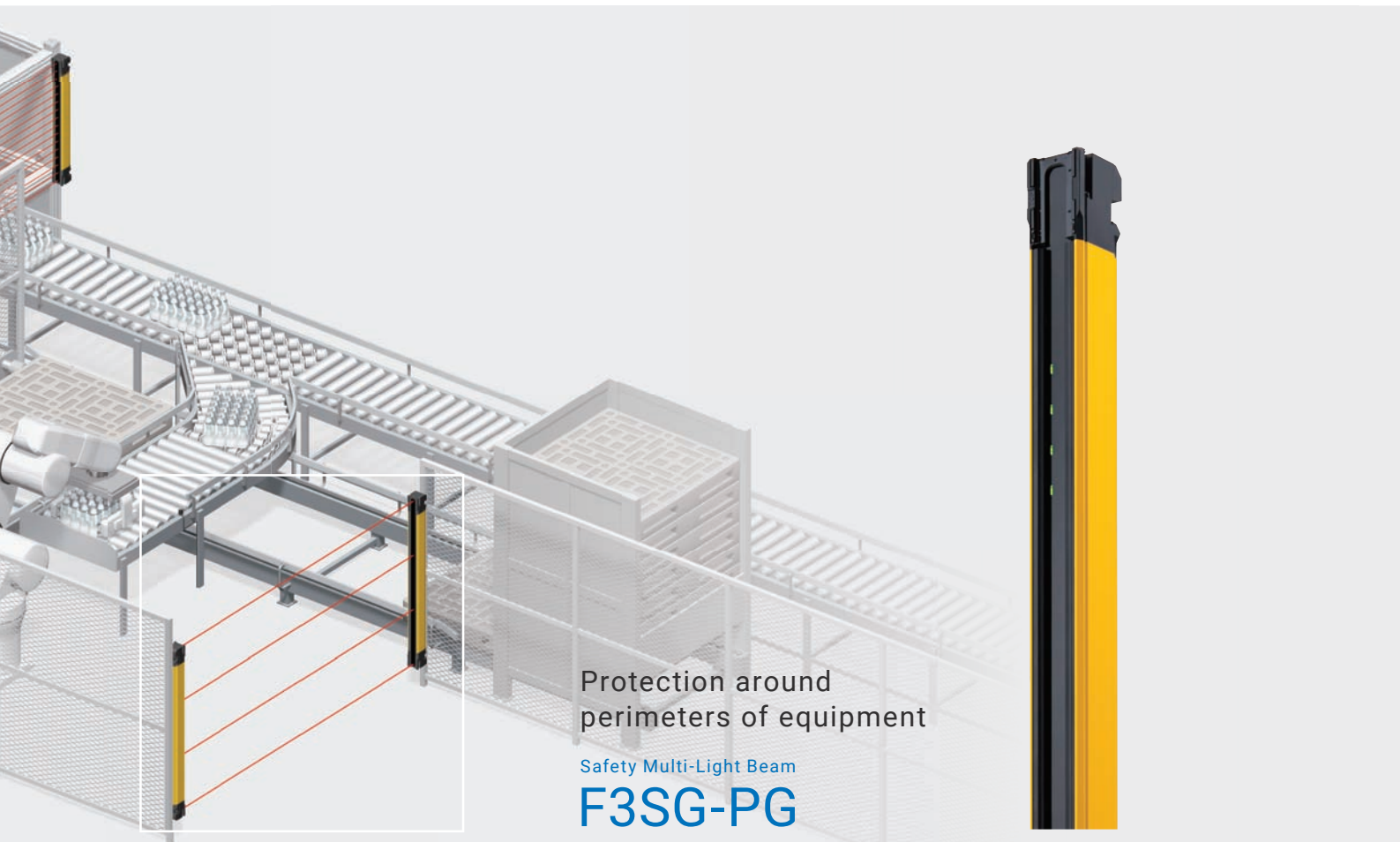

Protection around perimeters of equipment

Safety Multi-Light Beam
F3SG-PG

Perimeter Access Guarding

Beam gap **300/400/500 mm**

Product length **670 to 1,370 mm**

Max. operating range **20 m / 30 m**
Min./Typ.

Perimeter Guarding Long Range

Beam gap **300/400/500 mm**

Product length **630 to 1,370 mm**

Max. operating range **70 m / 110 m**
Min./Typ.

Perimeter Guarding Passive Mirror

Beam gap **300/400/500 mm**

Product length **670 to 1,370 mm**

Max. operating range **5 m / 8 m**
Min./Typ.

Mirror Column
(for F3SG-PG
Safety
Multi-Light Beam)
F39-PML

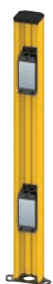

Laser
Alignment
Pointer
F39-PTS



Helps build safety systems for machines all over the world

This series conforms to worldwide safety standards.



PNP/NPN selection by changing the wiring allows you to easily bring and install the light curtain across the world.



The unique tightly sealed structure meets IP67G water and oil resistance and IP69K*.

* (Safety Light Curtain IP69K model F3SG-SR-K)



A broad lineup for flexible production line design

Create flexible design plans to suit your equipment requirements.

Long operating range thanks to unique optical design

The long-distance sensing capability enables reliable detection even in harsh environments.

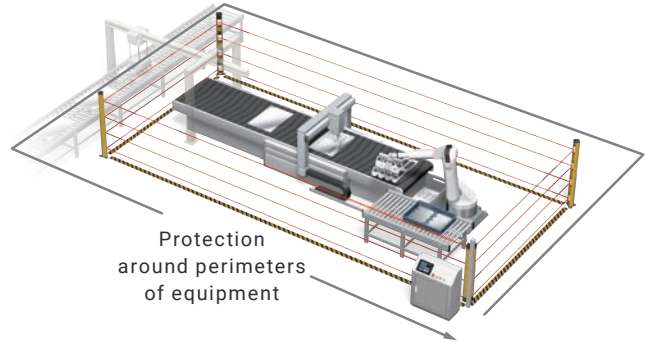
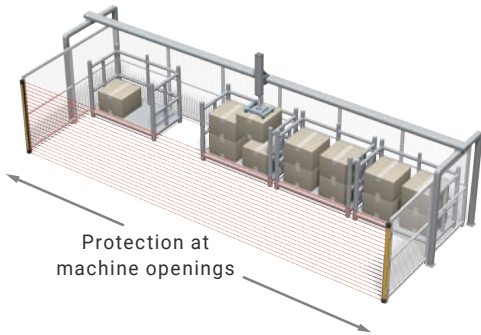

Safety Light Curtain
F3SG-SR
Series

20m Min.
30m Typ.

The high-power optical system provides stable detection up to 20 m even in harsh environments.

Safety Multi-Light Beam
F3SG-PG
Series

70 m Min.
110m Typ.

When mirror columns are installed in three corners: 50m Min./80m Typ.



Omron's unique compact design

The F3SG-SR Safety Light Curtain and F3SG-PG Safety Multi-Light Beam share the same compact housing. This makes mechanical design more flexible.

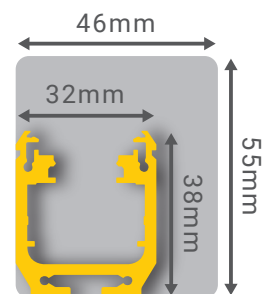

* Compared with OMRON Robotics and Safety Technologies, Inc's PA46 Perimeter Access Guarding Device. (Based on Omron investigation in June 2018)

Easy line layout changes

Simply replace a light curtain using the same accessories because the F3SG-SR Series and F3SG-PG Series share the same housing. There is no need to select and install optional accessories for a new light curtain.

Example : In order to secure a working space by installing the light curtain closer to the machine, the perimeter guarding model is replaced with the hand protection model

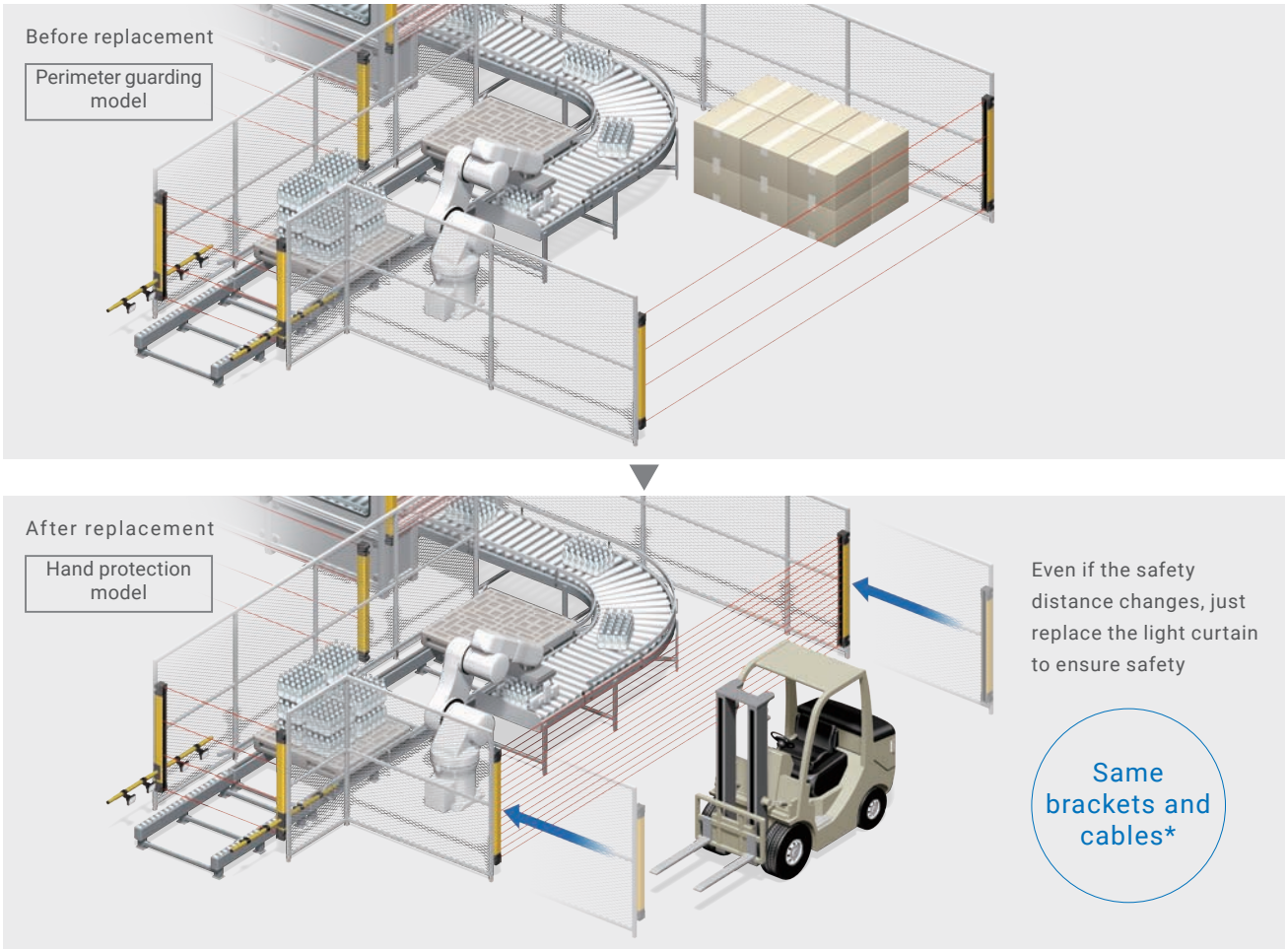

Just replace the light curtain with the same protective height*

F3SG-SR Series lineup

● Standard model ○ Flexible height model (Increments of 40 mm)

Protective height (mm)	160	200	240	280	320	360	400	440	480	520	560	600	640	670	680	720	760	800	840	880	920	960	970	1000	1040	1070	1120	1200	1280	1360	1370	
Finger Protection	●	○	○	○	○	○	○	○	○	○	○	○	○	○	○	○	○	○	○	○	○	○	○	○	○	○	○	○	○	○	○	○
Hand Protection	●	○	○	○	○	○	○	○	○	○	○	○	○	○	○	○	○	○	○	○	○	○	○	○	○	○	○	○	○	○	○	○
Arm/Leg Protection																																
Body Protection																																

Protective height (mm)	1400	1440	1520	1600	1680	1760	1800	1840	1920	2000	2080	2280	2480
Finger Protection	●												
Hand Protection	●	●	●	●	●	●	●	●	●	●	●	●	●
Arm/Leg Protection			●										
Body Protection													

F3SG-PG Series lineup

Product length (mm)	160	200	240	280	320	360	400	440	480	520	560	600	640	670	680	720	760	800	840	880	920	960	970	1000	1040	1070	1120	1200	1280	1360	1370	
Perimeter Access Guarding																																
Perimeter Guarding Long Range																																
Perimeter Guarding Passive Mirror																																

* Except for some models and optional accessories. See the F3SG-SR/PG Datasheet for details.

Flexible installation

Perfect fit

Protective heights are available in increments of 40 mm up to 1,000 mm*. The perfect protective height for any protected area ensures safety and eliminates the need for additional measures.

Problem

The light curtain that does not completely fit the protected area requires additional measures (e.g., adding a protection cover).

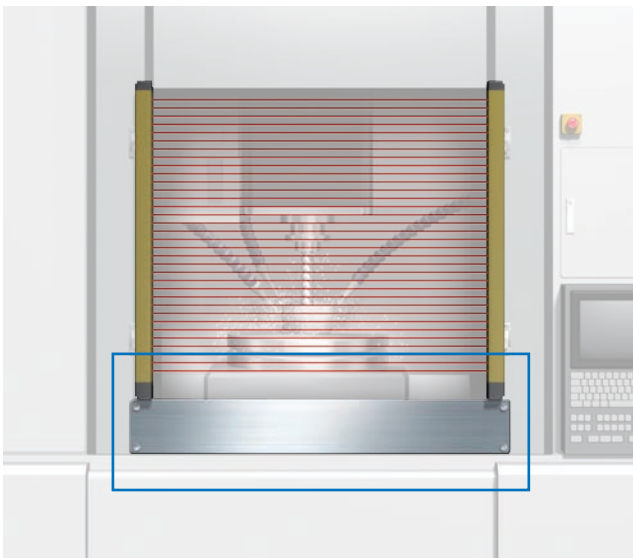

F3SG-SR*

The flexible height model requires no additional measures.

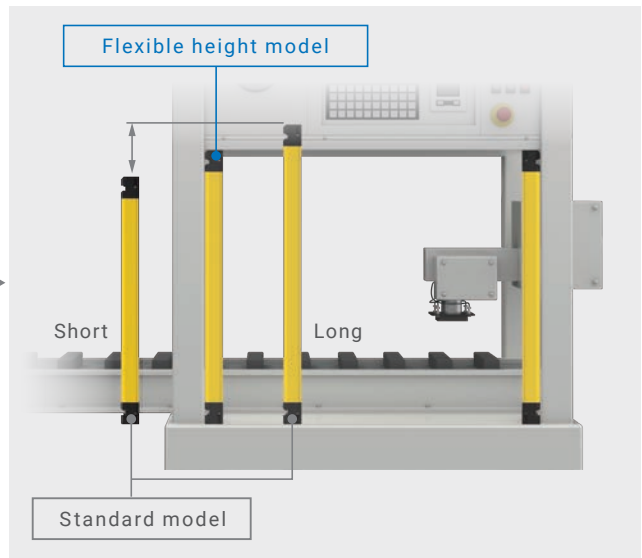

* F3SG-SR Finger and Hand Protection models only.

Protection without dead space

The F3SG-SR Series eliminates dead space that previously existed even when light curtains are series-connected or U-shape connected. Safer systems can be designed.

Problem

Dead space exists at the joint.

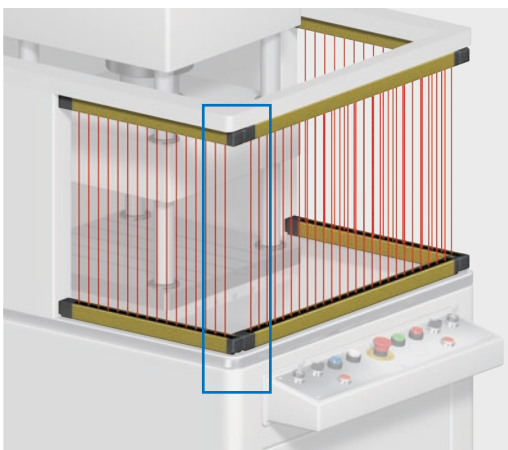

F3SG-SR*

Eliminates dead space and ensures safety.

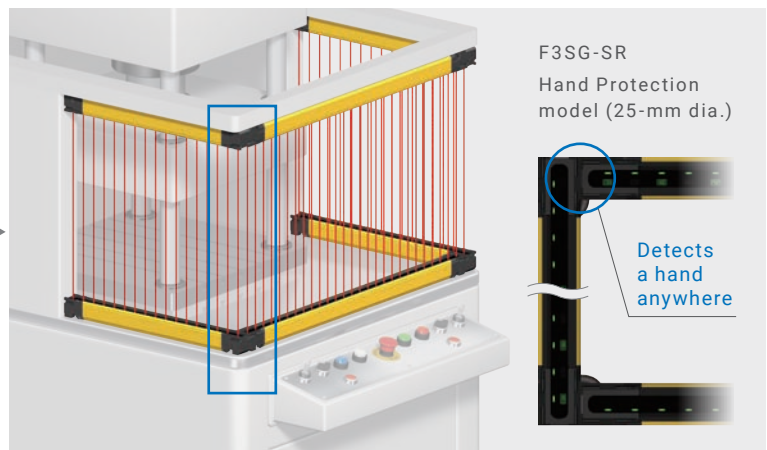

* Except for F3SG-SR Finger Protection models.

Simple wiring for flexible design

The F3SG-PG-C Perimeter Guarding Passive Mirror requires wiring of only the emitter/receiver. The use of mirror columns allows wiring at one location for protection around perimeters of equipment. They reduce wiring duct design and wiring time.

Wiring only the emitter/receiver

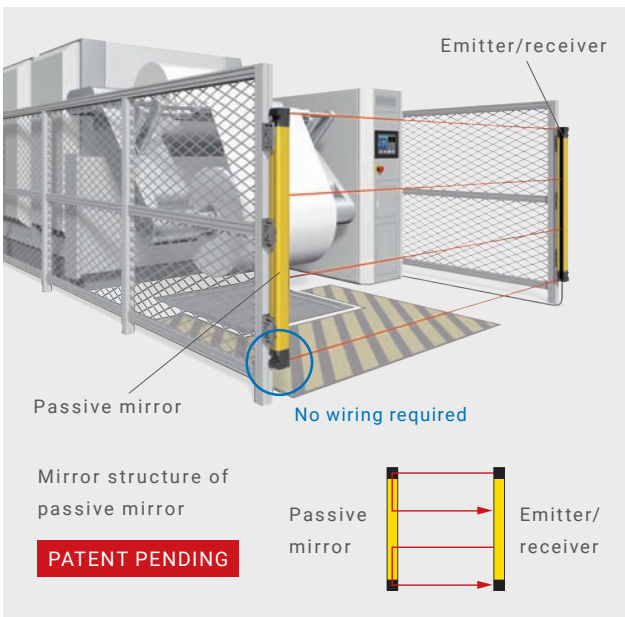

Wiring at one location for protection around perimeters of equipment

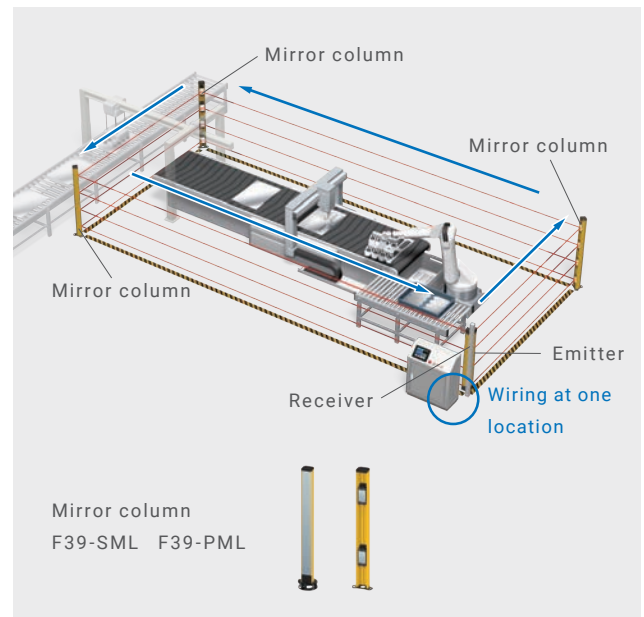

Two different synchronization systems

Choose from two different methods of synchronization between the emitter and receiver to suit your equipment.

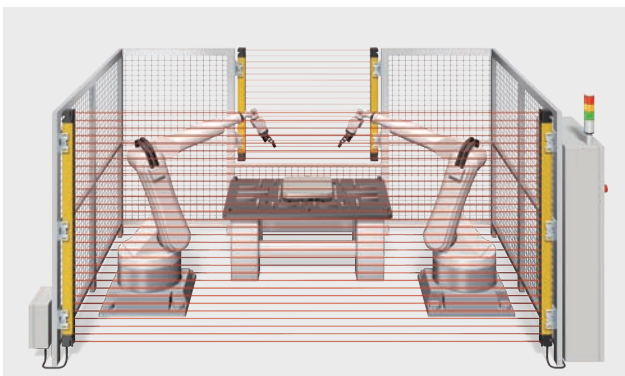

Optical synchronization

No sync lines are required. Connect emitter only to power supply.

Mutual interference prevention : Up to 2 sets

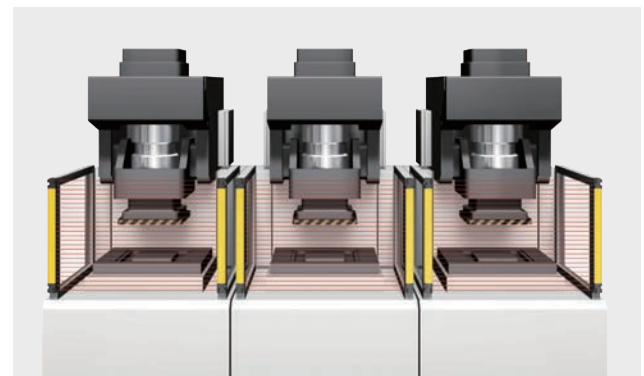
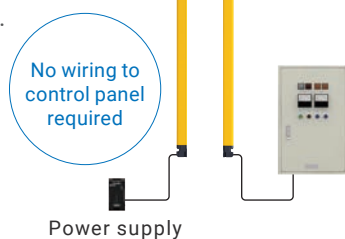

Wired synchronization

Mutual interference prevention : Up to 3 sets

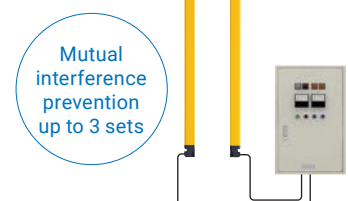

Color indication of beam status for quick and easy beam adjustment

Reduce beam adjustment time.

Area Beam Indicator (ABI) for an at-a-glance check of beam status

PATENTED

The ON or OFF state of the light curtain and low light intensity can be checked.

The ABI also facilitates fine adjustment of beams for long-distance sensing.



Easy to see



Stable state
Green :
Safety outputs ON
 The beams are unblocked.



Low light intensity
Orange :
Safety outputs ON
 Adjust beams or check if the light curtain is dirty.



Beams blocked
Red :
Safety outputs OFF*
 The beams in the area are blocked.

* The indicator of an unblocked area is OFF.

Note : Factory default setting.

The images of indicator illumination may vary somewhat from the actual products.

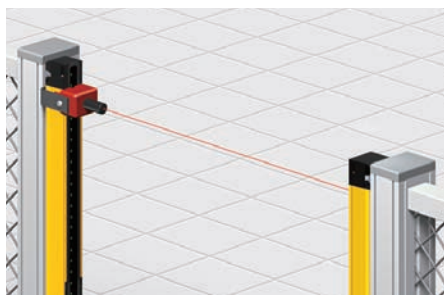

Laser Alignment Pointer

F39-PTS



F39-PTG

Assists with beam adjustment. Easy-to-see laser beam shows the sensor orientation. It can be attached on the spatter protection cover.

A variety of optional accessories for easy installation and angle adjustment

Reduce installation time and easily adjust beams after installation without relying on the expertise of experienced engineers.



Easy beam adjustment after installation

Problem

It is difficult to adjust beams after the light curtain is installed and the protection cover is attached.



F3SG-SR/PG

The rugged metal housing of the light curtain does not need a protection cover. Beams can be adjusted using optional brackets.



Adjustable Top / Bottom Bracket
F3SJ, F3SN Adapter
F39-LSGTB-SJ

This bracket used at the top and bottom of the light curtain provides horizontal adjustment of $\pm 22.5^\circ$.

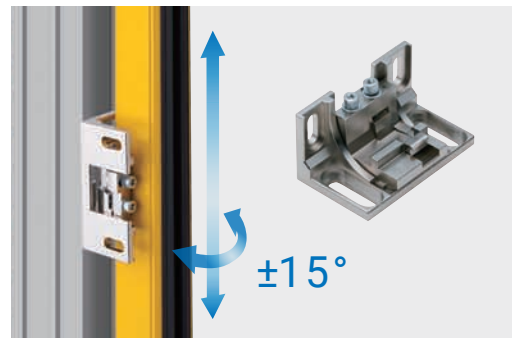

Adjustable Side-Mount Bracket (Intermediate Bracket)
F39-LSGA

This bracket provides horizontal adjustment of $\pm 15^\circ$ as well as vertical position adjustment.

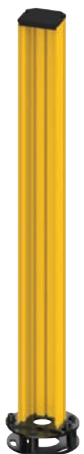

Floor Mount Column
F39-ST

This column can be installed independently of equipment or fences, almost anywhere.

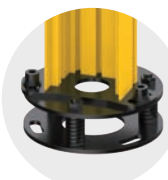

Mount-Column Adjustable Base
F39-STB

(The mount-column adjustable base is sold separately.)

Intelligent Tap
F39-SGIT-IL3

Settings can be copied and pasted between the same models of light curtains without using a PC, reducing time and effort to install many machines. Backed up settings are automatically restored at power on.

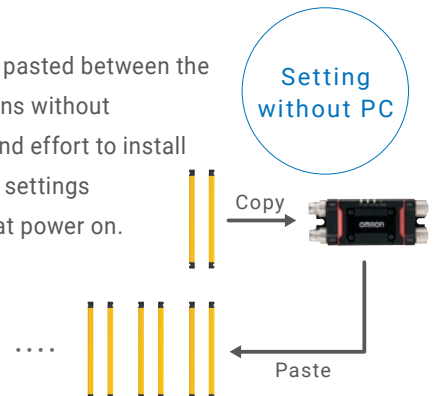

Reduced wiring system for various equipment

Wiring work during line installation and maintenance can be greatly reduced.

Simple wiring around large equipment

Problem

The distance of wiring around large facilities generally becomes long.

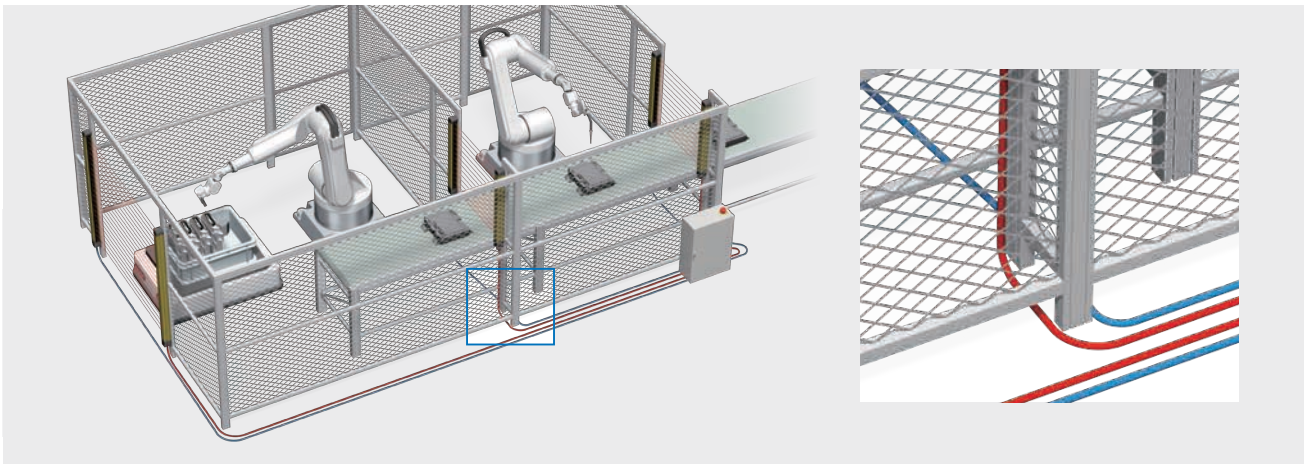

F3SG-SR/PG

The reduced wiring system reduces the number of cables and terminal blocks and wiring time.

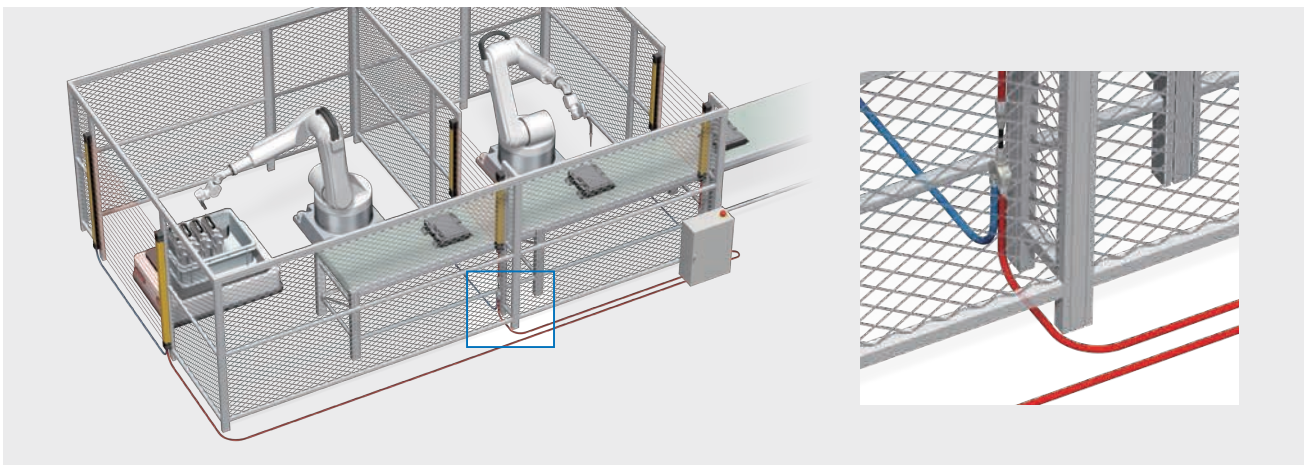

Reduced wiring connector



Y-Joint Plug /
Socket Connector
F39-GCNY2

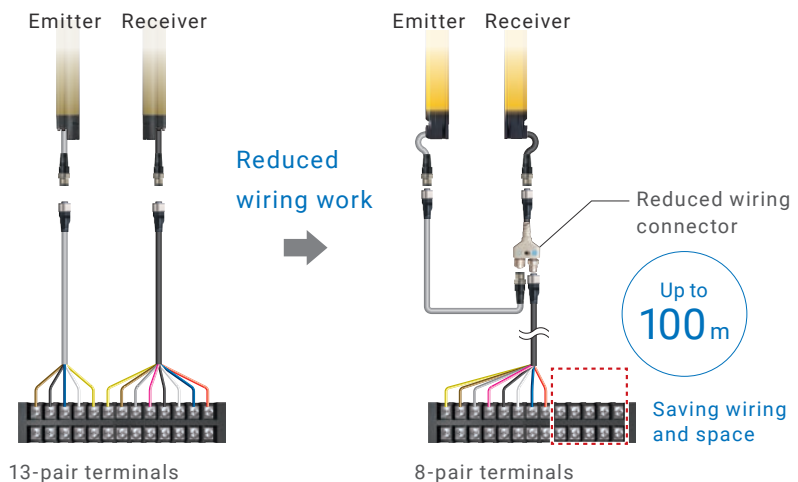

Note: Refer to the User's Manual (Cat. No. Z405) for more information on cable extension.

One cable connection to control panel

Options provide simple wiring for muting.

Problem

In order to maintain productivity, the light curtains are often used with muting sensors, which makes wiring in the control panel more complicated.

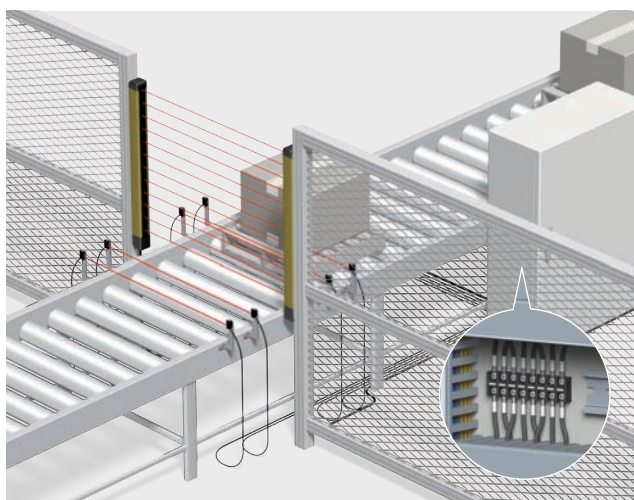

F3SG-SR/PG

Options to reduce wiring simplify wiring and installation of muting sensors.

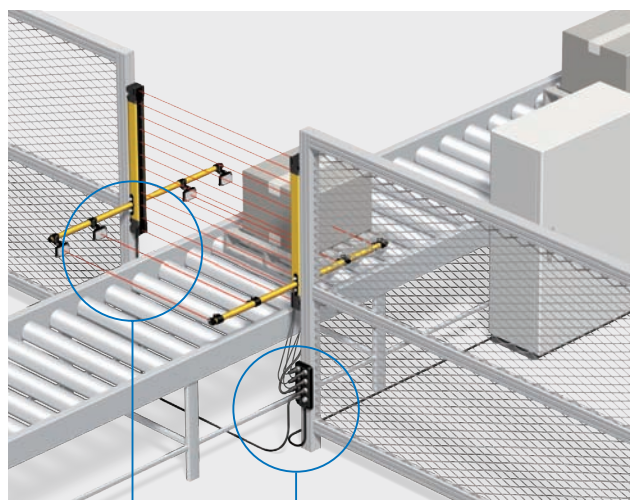

Muting Sensor Arm Mounter F39-FMA

The muting sensor arm mounter facilitates installation of a muting sensor.

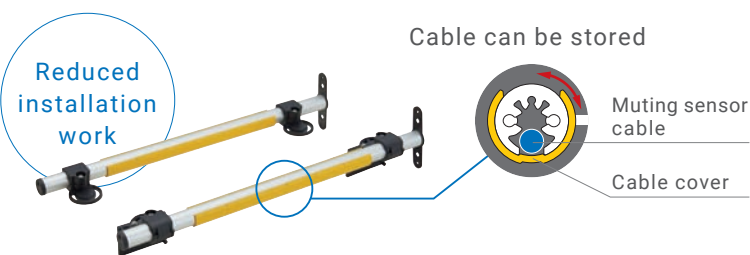

Muting Sensor Connection Box F39-GCN5

The connection box simplifies wiring for muting, and only one cable is used to connect to the control panel.



Note : The E3Z Muting Sensor is sold separately.

Smartclick connectors to quickly connect cables



Smartclick is a registered trademark of OMRON Corporation.

Insert fully



Easy and secure connection

Robustness for operation in harsh environments

Specifications suitable for use in any environment contribute to stable operation.

Light curtains tend to malfunction in harsh environments where safety measures are required.



Cold storage warehouse

Safety measures cannot be implemented because there is no light curtain that can be used in cold environments.

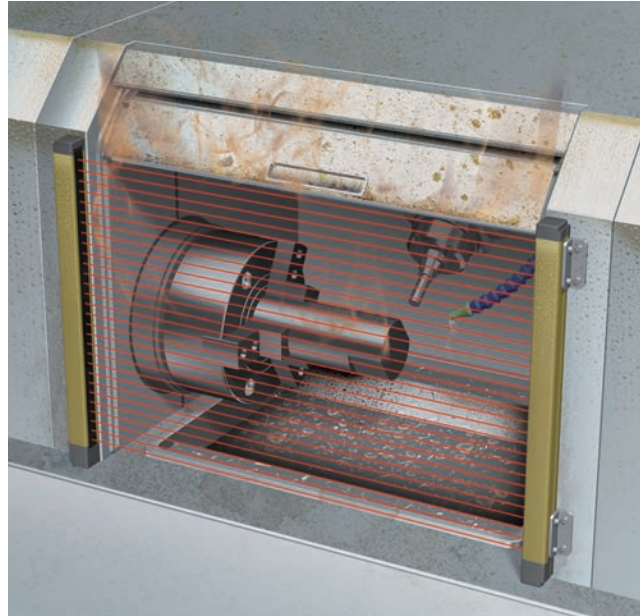

Metal working process

Oil that gets inside the light curtain causes failure at locations where oil mist is present.

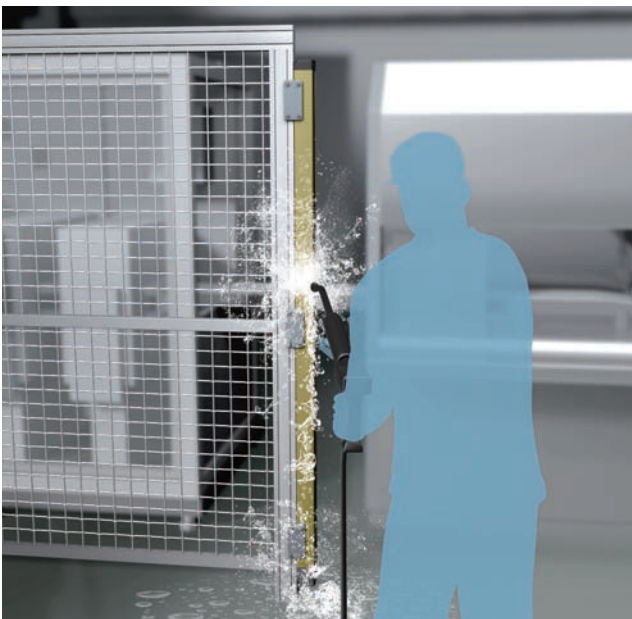

Food processing line

Cleaning solution that gets inside the light curtain during machine wash-down causes failure.

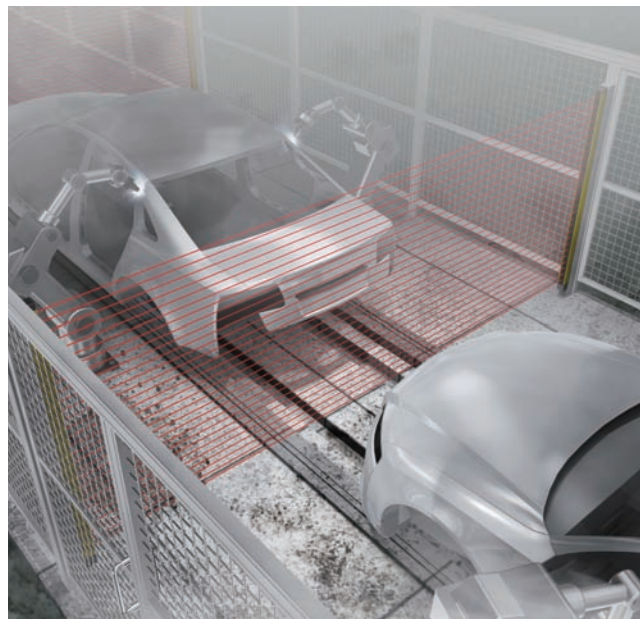

Use in harsh environments

The spattered or dusty optical surface of the light curtain causes a malfunction or an unplanned machine stop.

Use in temperatures down to **-30°C**

Waterproof, oil resistance
IP65/IP67
IP67G

IEC 60529
JIS C 0920 Annex 1



Tightly sealed structure improved environmental resistance

The unique structure firmly presses the optical surface. Stable sealing performance resists penetration of liquid inside the light curtain, which improves environmental resistance of the housing.

PATENTED

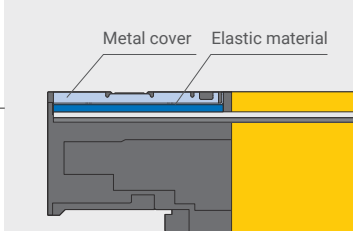

Technology 1 to tightly seal the cap

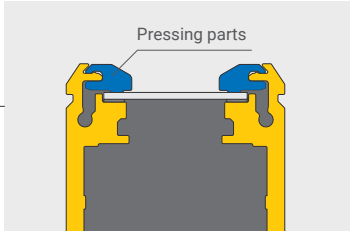

Technology 2 to tightly seal the housing

IP69K model for high-pressure wash-down applications

F3SG-SR-K



Waterproof
IP69K

ISO 20653

High-power optical system provides stable detection



The maximum operating range of the F3SG-SR Safety Light Curtain is 20 m and of the F3SG-PG Safety Multi-Light Beam 70 m. The high-power beam is robust in harsh environments.

Metal housing increases ruggedness

Laser marked information withstands harsh environments

Easy maintenance

Even inexperienced operators can easily check status and replace light curtains.

Easy error diagnosis with clear color indicators

The light curtain status can be checked at a glance.



Status indicator

Clear LED indicators with labels help perform predictive maintenance by dirt detection and determine the optimal replacement timing.

Colors and patterns indicate the status

Status indicator*	Color	Status
	Red/Illuminated	LOCKOUT state due to a recoverable error
	Red/Blinking	LOCKOUT state due to a replacement-recommended error
	Orange/Illuminated	Safety outputs are instantaneously turned OFF due to ambient light, vibration, or noise
	Orange/Blinking	The Intelligent Tap is in LOCKOUT state

* The **M** status indicator is used for the 14-mm detection capability model.

Lamp

Output status can be checked at a glance.

F39-SGLP



Output information can be assigned to the lamp and ABI.

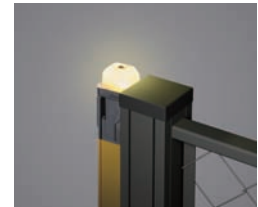

Status, such as light intensity drop, can be checked from a distance.

For information on other indicators, refer to the F3SG-SR/PG Datasheet *Indicator* or *Troubleshooting*.

Back up and restore settings with Intelligent Tap

Replacement and setting time during maintenance can be reduced to 1/10 or less*.

Plug & Work for quick replacement

Install the Intelligent Tap to automatically copy the settings of the replaced light curtain to a new one. Virtually anyone can easily replace light curtains and immediately restart the machine.

Replacement and setting time reduced to 1/10 or less*



Intelligent Tap
F39-SGIT-IL3



* Based on Omron investigation in June 2018.

Preventive maintenance

The status of the light curtain is monitored, and the abnormal state is displayed. This helps minimize machine downtime.

Visualization of status

Various devices can be connected via IO-Link.*1
 Low light intensity due to dirt on the light curtain can be displayed on the monitor, enabling preventive maintenance prior to erroneous detection.

IO-Link



No PC required on site

Easy on-site monitoring

The Bluetooth® communication unit allows you to monitor information about device stoppages on mobile devices.



SD Manager 3 Mobile APP

Note 1. Screen images for illustration purposes only.
 2. You need to create screens.

Process data

- Auxiliary output status *2
- Muting input status
- Sequence error information
- Unstable state information (each ch)
- Power voltage information
- OSSD output status
- Reset/EDM/override input status
- Instantaneous block information (each ch)
- Light curtain/Intelligent Tap lockout information

Service data

- Light curtain information
- Light intensity information (1 byte: 0-255)
- Light curtain settings
- Light curtain internal status information
- Intelligent Tap power-on time information
- Intelligent Tap information
- Error log (4 errors)

Requirements

Android™ 7.0 or higher



Startup screen



Error log screen



Light level monitoring



*1. Refer to the IO-Link Series Catalog (Cat. No. Y229) for details. *2. Auxiliary output can be set using the SD Manager 3.

Easy setting via PC software SD Manager 3

The configuration tool allows you to easily monitor status and make settings without using a safety controller.

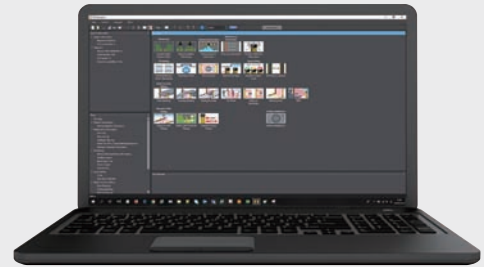

Manually loaded machining : PSDI



PSDI*, provided as standard, reduces operator effort and increases productivity

There is no need for the operator to press a two-hand control switch, saving operating time and increasing operating efficiency.

Single break

The machine restarts when the light curtain is interrupted and reset once.

Example : Manual loading and automatic unloading press

Double break

The machine restarts when the interruption and reset are repeated twice.

Example : Manual loading and manual unloading press

* PSDI : Presence Sensing Device Initiation
Read the *User's Manual* (Cat. No. Z405) before using.
Note: Comply with laws and regulations in the countries where the machine operates.

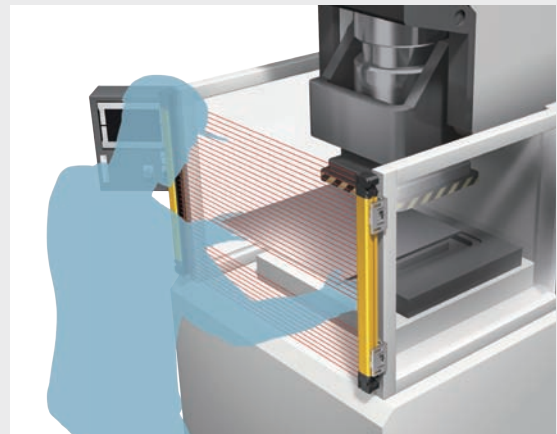

Dangerous restart prevention : Pre-Reset



The Pre-Reset function prevents possible accidents

This function prevents the restart of equipment while an unseen worker is still near the robot, ensuring operators' safety.

- 1 Press the pre-reset switch inside the hazardous zone.
- 2 Get out of the hazardous zone.
- 3 Press the reset switch in the control panel to restart the light curtain.
The machine is ready for restart.

The equipment cannot be restarted until the pre-reset switch of the light curtain is pressed and the light curtain is reset.

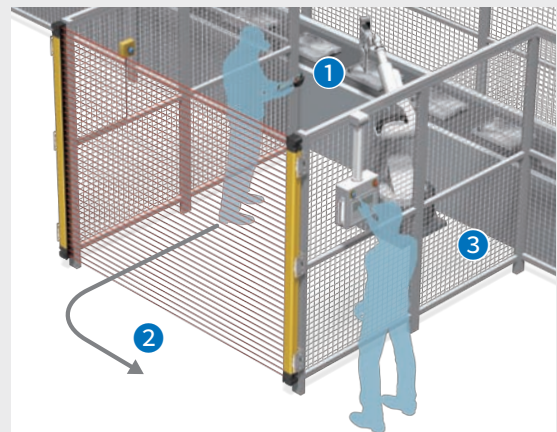

Ignoring interrupted beams : Reduced Resolution

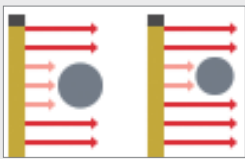

Reduced Resolution changes the detection capability of the light curtain

Even when objects (with a size of 1 to 3 interrupted beams) are present discontinuously, this function ignores them and keeps the safety outputs ON. This helps maintain productivity.

Example : Arm and body protection

Safety output is kept ON even if worker's finger and an object interrupt 2 beams because they are allowed to enter.

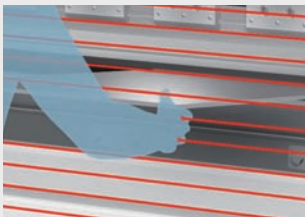

When worker's arm or body, which interrupts 3 beams is detected, safety output is turned OFF.

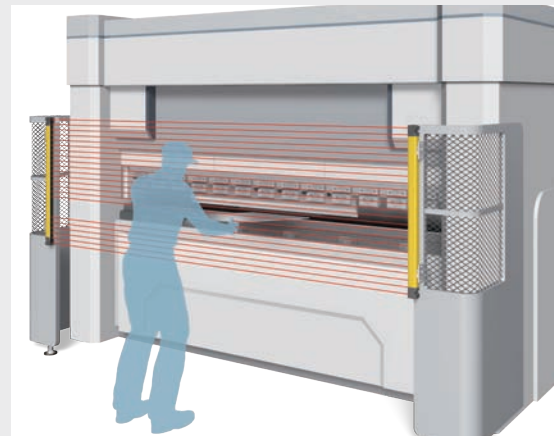

Note : Ensure that the desired safety distance is maintained.

Built-in standard safety functions

Monitoring

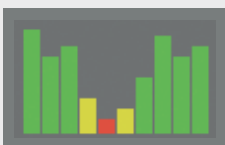

Incident / Ambient Light Level Information

Safety function setting

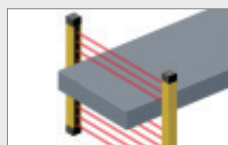

Fixed Blanking

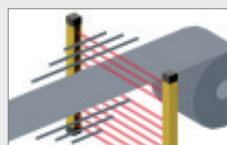

Floating Blanking

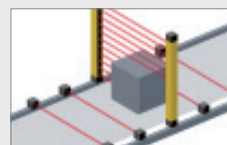

Muting/Override

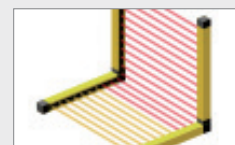

Warning Zone

I/O setting

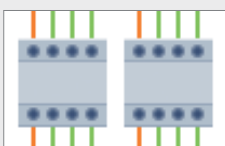

Interlock / External Device Monitoring

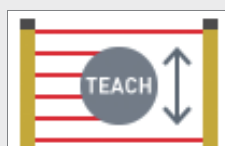

Teach-in Input

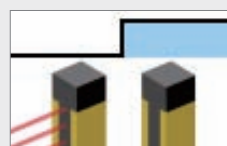

External Test Input

Operation state change

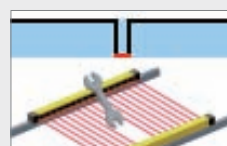









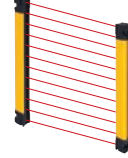
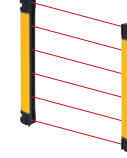
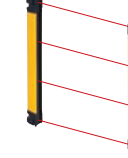























Response Time Adjustment



Operating Range Selection

F3SG-SR/PG Series Features and specifications

Series		Protection at machine openings :					
		Advanced/Standard					
							
Application	 Finger Protection						
	 Hand Protection						
	 Arm/Leg Protection						
	 Body Protection						
Specification	Detection capability	14-mm dia.	25-mm dia.	45-mm dia.	85-mm dia.		
	Beam gap	10 mm	20 mm	40 mm	80 mm		
	Max. operating range Min./Typ.	10 m / 15 m	20 m / 30 m	20 m / 30 m	20 m / 30 m		
	Protective height (Product length)	160 to 2,000 mm	160 to 2,480 mm	240 to 1,520 mm	280 to 920 mm		
	Number of beams	15 to 199	8 to 124	6 to 38	4 to 12		
	Degree of protection	IP65, IP67, and IP67G					
Feature	Mutual interference prevention	 (No settings required for wired synchronization)					
	PNP/NPN Selection						
	External Test						
	Interlock						
	Lockout Reset						
	Pre-Reset						
	PSDI						
	External Device Monitoring (EDM)						
	Auxiliary Output						
	Muting						
	Blanking						
	Reduced Resolution						
	Warning Zone						
	Operating Range Selection			 /  / 			
	Response Time Adjustment						
	Area Beam Indicator (ABI)			 * Advanced models only			
Designated Beam Output							
Connection/wiring	Cascade connection	Available	Available	Available	Available		
	Reduced wiring system*1	Available	Available	Available	Available		
Optional accessory	Laser Alignment Pointer	Available	Available	Available	Available		
	Lamp	Available	Available	Available	Available		
	Mirror Column	Available	Available	Available	Available		
	Muting Sensor Arm Mounter/Connection Box	Available	Available	Available	Available		

 Setting by DIP switch on Intelligent Tap  Setting by configuration tool SD Manager 3  Setting by wiring
 Setting by end cap

Safety Light Curtain F3SG-SR		Protection around perimeters of equipment : Safety Multi-Light Beam F3SG-PG		
IP69K model, Standard		Perimeter Access Guarding	Perimeter Guarding Long Range	Perimeter Guarding Passive Mirror
14-mm dia.	25-mm dia.	30-mm dia. + beam gap		
10 mm	20 mm	300 mm/400 mm/500 mm		
8 m / 12 m	16 m / 24 m	20 m / 30 m	70 m / 110 m	5 m / 8 m
320 to 1,800 mm	320 to 1,840 mm	670 to 1,370 mm		
31 to 179	16 to 92	2, 3 and 4		2 and 4
IP65, IP67, and IP69K		IP65 and IP67		
No settings required for wired synchronization		(No settings required for wired synchronization)		
				Not supported
/ *2		/		
/ *2		/		
*2			Not supported	
/ *2		/		
*2				
*2				
/ *2			Not supported	
*2			Not supported	
*2			Not supported	
/ *2		Not supported	/ /	Not supported
*2				
Not supported				
*2				
Not available		Not available	Not available	Not available
Not available		Available	Available	Available
Not available		Available	Available	Available
Not available		Available	Available	Available *3
Not available		Available	Available	Available *4

*1. The reduced wiring system includes the Y-joint plug/socket connector, reset switch connector, muting sensor connection box, and muting sensor arm mounter. *2. When connecting F3SG-SR-K with open-ended cable to the intelligent tap, use a relay terminal block. *3. The lamp can be attached to the emitter/receiver. *4. The perimeter guarding passive mirror cannot be used with the mirror column.

Safety Light Curtain/Safety Multi-Light Beam

F3SG-SR/PG Series Product selection

Choose your safety light curtain and optional accessories from our F3SG-SR/PG Series through a 4-step process.

STEP 1
Choose a safety
light curtain

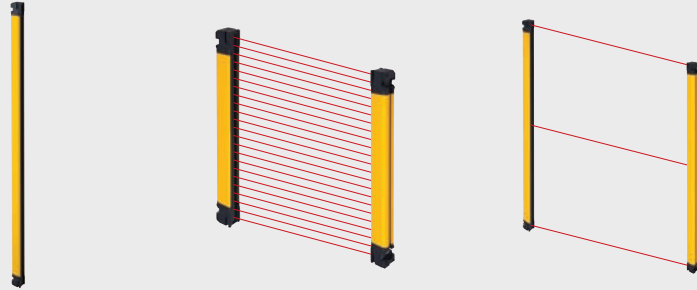

STEP 2
Choose
a mounting
bracket

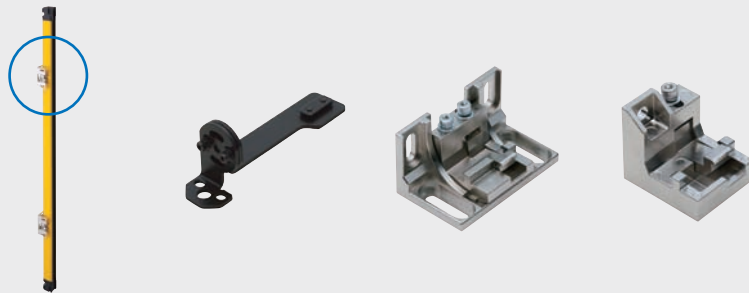

STEP 3*
Choose a wiring
method



STEP 4*
Choose the
optional
accessories
you need



* There is no need to follow STEP 3 and STEP 4 when the IP69K model is selected.

STEP 1 Choose a safety light curtain

Select a light curtain to suit your application.

Protection
at machine openings

SR

Safety Light Curtain
F3SG-SR Page 24
IP69K model Page 32

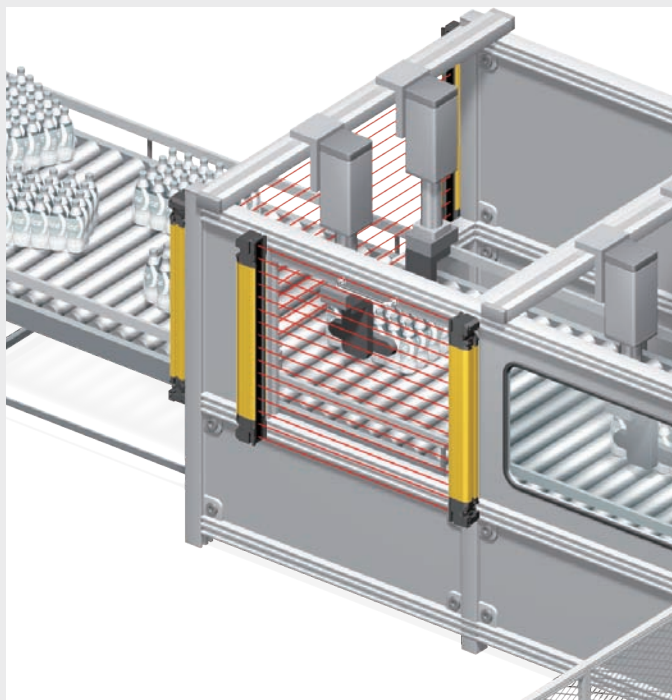

Protection around
perimeters of equipment

PG

Safety Multi-Light Beam
F3SG-PG Page 26

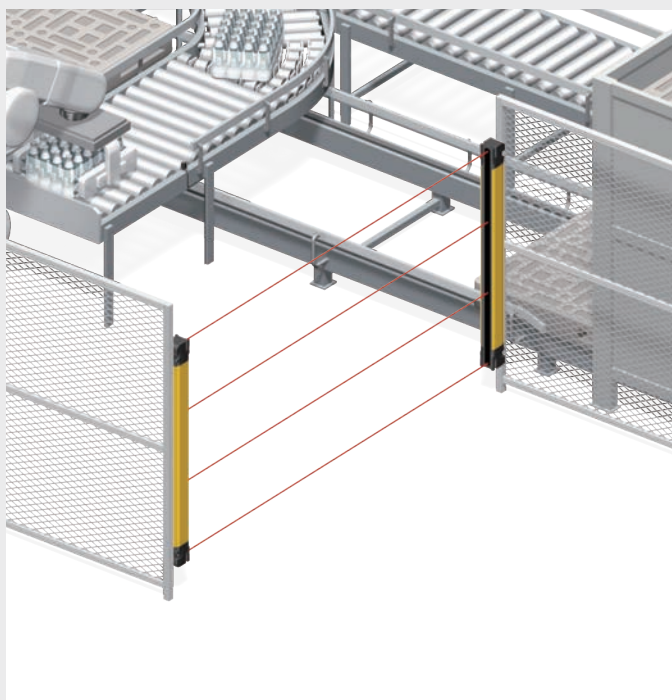

Protection at machine openings

SR Safety Light Curtain
F3SG-SR

Complete the model number.

F3SG-4SR - -
① ③ ② ④

1 Select an application.

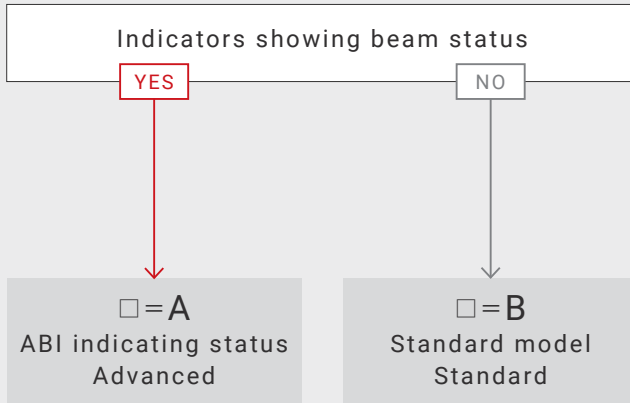

2 Select detection capability.

Type	②
 Finger Protection Detection capability 14-mm dia. 	<input type="checkbox"/> <input type="checkbox"/> = 14
 Hand Protection Detection capability 25-mm dia. 	<input type="checkbox"/> <input type="checkbox"/> = 25
 Arm/Leg Protection Detection capability 45-mm dia. 	<input type="checkbox"/> <input type="checkbox"/> = 45
 Body Protection Detection capability 85-mm dia. 	<input type="checkbox"/> <input type="checkbox"/> = 85

3 Select protective height.

Finger Protection

Protective height (mm)	Number of beams	③	④*
160	15	<input type="checkbox"/> <input type="checkbox"/> <input type="checkbox"/> <input type="checkbox"/> = 0160	
200	19	<input type="checkbox"/> <input type="checkbox"/> <input type="checkbox"/> <input type="checkbox"/> = 0200	F
240	23	<input type="checkbox"/> <input type="checkbox"/> <input type="checkbox"/> <input type="checkbox"/> = 0240	
280	27	<input type="checkbox"/> <input type="checkbox"/> <input type="checkbox"/> <input type="checkbox"/> = 0280	F
320	31	<input type="checkbox"/> <input type="checkbox"/> <input type="checkbox"/> <input type="checkbox"/> = 0320	
360	35	<input type="checkbox"/> <input type="checkbox"/> <input type="checkbox"/> <input type="checkbox"/> = 0360	F
400	39	<input type="checkbox"/> <input type="checkbox"/> <input type="checkbox"/> <input type="checkbox"/> = 0400	
440	43	<input type="checkbox"/> <input type="checkbox"/> <input type="checkbox"/> <input type="checkbox"/> = 0440	F
480	47	<input type="checkbox"/> <input type="checkbox"/> <input type="checkbox"/> <input type="checkbox"/> = 0480	
520	51	<input type="checkbox"/> <input type="checkbox"/> <input type="checkbox"/> <input type="checkbox"/> = 0520	F
560	55	<input type="checkbox"/> <input type="checkbox"/> <input type="checkbox"/> <input type="checkbox"/> = 0560	
600	59	<input type="checkbox"/> <input type="checkbox"/> <input type="checkbox"/> <input type="checkbox"/> = 0600	F
640	63	<input type="checkbox"/> <input type="checkbox"/> <input type="checkbox"/> <input type="checkbox"/> = 0640	
680	67	<input type="checkbox"/> <input type="checkbox"/> <input type="checkbox"/> <input type="checkbox"/> = 0680	F
720	71	<input type="checkbox"/> <input type="checkbox"/> <input type="checkbox"/> <input type="checkbox"/> = 0720	F
760	75	<input type="checkbox"/> <input type="checkbox"/> <input type="checkbox"/> <input type="checkbox"/> = 0760	F
800	79	<input type="checkbox"/> <input type="checkbox"/> <input type="checkbox"/> <input type="checkbox"/> = 0800	
840	83	<input type="checkbox"/> <input type="checkbox"/> <input type="checkbox"/> <input type="checkbox"/> = 0840	F
880	87	<input type="checkbox"/> <input type="checkbox"/> <input type="checkbox"/> <input type="checkbox"/> = 0880	F
920	91	<input type="checkbox"/> <input type="checkbox"/> <input type="checkbox"/> <input type="checkbox"/> = 0920	F
960	95	<input type="checkbox"/> <input type="checkbox"/> <input type="checkbox"/> <input type="checkbox"/> = 0960	F
1000	99	<input type="checkbox"/> <input type="checkbox"/> <input type="checkbox"/> <input type="checkbox"/> = 1000	
1200	119	<input type="checkbox"/> <input type="checkbox"/> <input type="checkbox"/> <input type="checkbox"/> = 1200	
1400	139	<input type="checkbox"/> <input type="checkbox"/> <input type="checkbox"/> <input type="checkbox"/> = 1400	
1600	159	<input type="checkbox"/> <input type="checkbox"/> <input type="checkbox"/> <input type="checkbox"/> = 1600	
1800	179	<input type="checkbox"/> <input type="checkbox"/> <input type="checkbox"/> <input type="checkbox"/> = 1800	
2000	199	<input type="checkbox"/> <input type="checkbox"/> <input type="checkbox"/> <input type="checkbox"/> = 2000	

* Flexible height model (Increments of 40 mm)

Hand Protection

Protective height (mm)	Number of beams	③	④*
160	8	□□□□=0160	
200	10	□□□□=0200	F
240	12	□□□□=0240	
280	14	□□□□=0280	F
320	16	□□□□=0320	
360	18	□□□□=0360	F
400	20	□□□□=0400	
440	22	□□□□=0440	F
480	24	□□□□=0480	
520	26	□□□□=0520	F
560	28	□□□□=0560	
600	30	□□□□=0600	F
640	32	□□□□=0640	
680	34	□□□□=0680	F
720	36	□□□□=0720	
760	38	□□□□=0760	F
800	40	□□□□=0800	
840	42	□□□□=0840	F
880	44	□□□□=0880	
920	46	□□□□=0920	F
960	48	□□□□=0960	
1000	50	□□□□=1000	F
1040	52	□□□□=1040	
1120	56	□□□□=1120	
1200	60	□□□□=1200	
1280	64	□□□□=1280	
1360	68	□□□□=1360	
1440	72	□□□□=1440	
1520	76	□□□□=1520	
1600	80	□□□□=1600	
1680	84	□□□□=1680	
1760	88	□□□□=1760	
1840	92	□□□□=1840	
1920	96	□□□□=1920	
2080	104	□□□□=2080	
2280	114	□□□□=2280	
2480	124	□□□□=2480	

Arm/Leg Protection

Protective height (mm)	Number of beams	③
240	6	□□□□=0240
400	10	□□□□=0400
560	14	□□□□=0560
720	18	□□□□=0720
880	22	□□□□=0880
1200	30	□□□□=1200
1520	38	□□□□=1520

Body Protection

Protective height (mm)	Number of beams	③
280	4	□□□□=0280
440	6	□□□□=0440
600	8	□□□□=0600
760	10	□□□□=0760
920	12	□□□□=0920

* Flexible height model (Increments of 40 mm)



Safety Multi-Light Beam

F3SG-PG

Complete the model number.

F3SG-4PGA -
2 1

1 Select an application and then select a beam gap and number of beams.

Select an application.

Protection around large equipment (operating range > 20 m)

NO

↓

Protection around small equipment (operating range < 5 m)

NO

↓

Standard model
Perimeter Access
Guarding

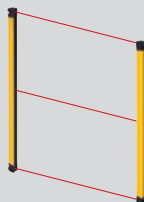

F3SG-PGA-A

YES

↓

Simple wiring
Perimeter
Guarding
Passive Mirror

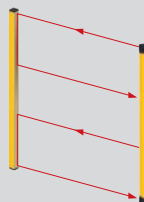

F3SG-PGA-C

YES

↓

Protection up
to 70 m long
Perimeter
Guarding Long
Range

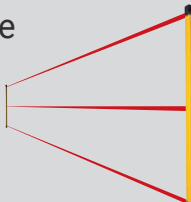

F3SG-PGA-L

Select a beam gap and number of beams.

Beam gap/ number of beams	1	Beam gap/ number of beams	1	Beam gap/ number of beams	1
500 mm/2 beams	<input type="text"/> <input type="text"/> =2A	500 mm/2 beams	<input type="text"/> <input type="text"/> =2C	500 mm/2 beams	<input type="text"/> <input type="text"/> =2L
400 mm/3 beams	<input type="text"/> <input type="text"/> =3A	-	-	400 mm/3 beams	<input type="text"/> <input type="text"/> =3L
300 or 400 mm/ 4 beams	<input type="text"/> <input type="text"/> =4A	300 or 400 mm/ 4 beams	<input type="text"/> <input type="text"/> =4C	300 or 400 mm/ 4 beams	<input type="text"/> <input type="text"/> =4L

2 Select Product length.

Product length (mm)	Number of beams	2
670	2	<input type="checkbox"/> <input type="checkbox"/> <input type="checkbox"/> <input type="checkbox"/> =0670
970	3	<input type="checkbox"/> <input type="checkbox"/> <input type="checkbox"/> <input type="checkbox"/> =0970
1070	4	<input type="checkbox"/> <input type="checkbox"/> <input type="checkbox"/> <input type="checkbox"/> =1070
1370	4	<input type="checkbox"/> <input type="checkbox"/> <input type="checkbox"/> <input type="checkbox"/> =1370

STEP 2 Choose an optional mounting bracket (sold separately)

Brackets used when beam adjustment is not required after the light curtain is installed

Standard Bracket
(Intermediate Bracket)
F39-LSGF

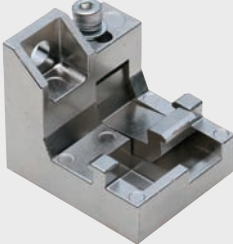

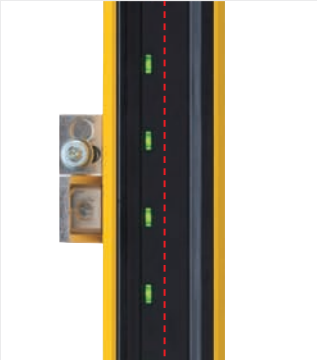

- Side mounting and backside mounting
- Beams not adjustable after installation
- Two brackets per set

Suitable for mounting on an aluminum profile so that its center is aligned with the center of beams.

Brackets that allow beam adjustment after the light curtain is installed

Adjustable Side-Mount Bracket
(Intermediate Bracket)
F39-LSGA



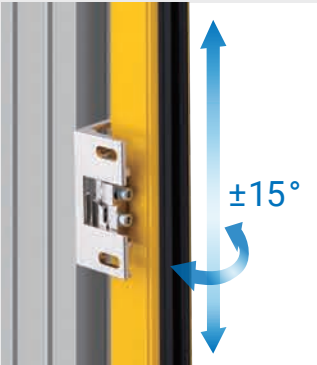

- Vertical adjustment
Angle adjustment range : $\pm 15^\circ$
- Side mounting and backside mounting
- Two brackets per set

**Adjustable Top/
Bottom Bracket**
F3SJ, F3SN Adapter
F39-LSGTB-SJ





- Used at the top and bottom of the light curtain
- Angle adjustment range : $\pm 22.5^\circ$
- For replacement of F3SJ or F3SN Series
- Side mounting and backside mounting
- Two brackets per set

Mounting brackets to easily replace your existing Omron light curtains are also available.

For replacement of F3SG-RA/RE Series
Adjustable Top/Bottom Bracket
F3SG-RA/RE Adapter
F39-LSGTB-RE



For replacement of MS4800 Series and F3SR-B Series
Adjustable Top/Bottom Bracket
MS4800/F3SR Adapter
F39-LSGTB-MS



STEP 3 Choose a wiring method

One light curtain

* Emitter-side cables (1, 3, 5, 7) are not necessary with the F3SG-PG-C (passive mirror).

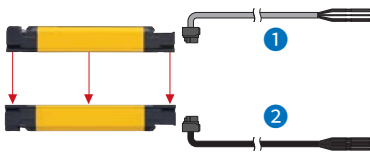

• Cable extension (up to 100 m)

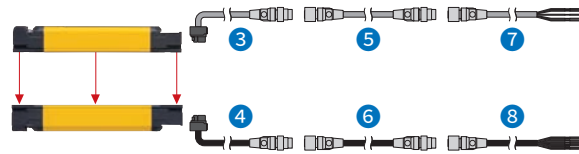

Series-connected

• Side-by-side cascading (12 cm)

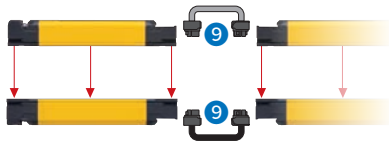

• Cascading cable extension (up to 10 m)

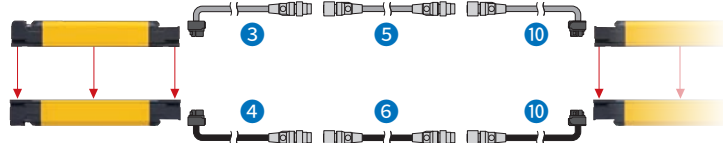

Use of reduced wiring connector

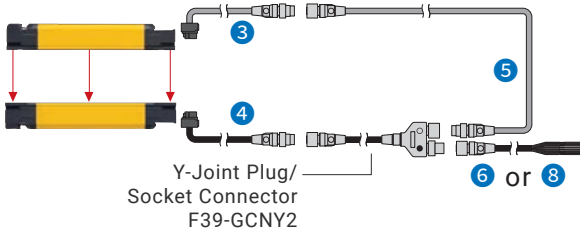

Use of Intelligent Tap

• Always connected (Wired synchronization)

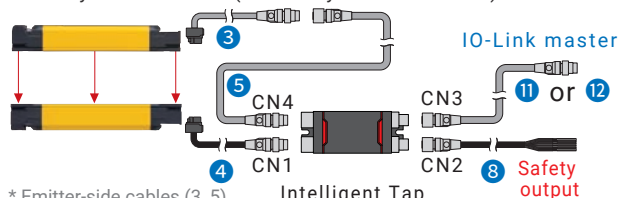

* Emitter-side cables (3, 5) are not necessary with the F3SG-PG-C (passive mirror).

Replacement of Omron light curtain

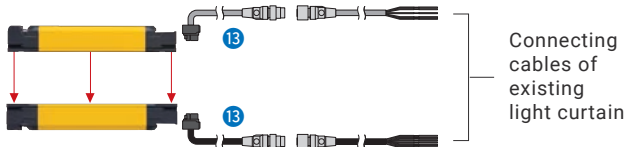

• Connected for setting (optical synchronization)

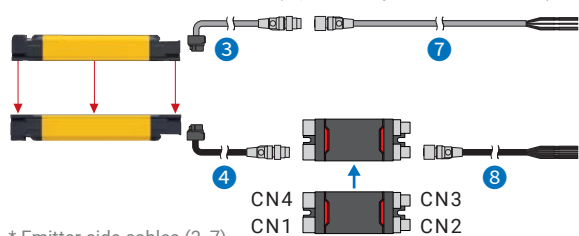

* Emitter-side cables (3, 7) are not necessary with the F3SG-PG-C (passive mirror).

Optional cables (sold separately)

No.	Product name	Appearance	Model	Cable length	Remarks
1	Root-Straight Cable		F39-JG□C-L	3, 7, 10 m	For emitter, gray
2	Root-Straight Cable		F39-JG□C-D	3, 7, 10 m	For receiver, black
3	Root-Plug Cable for Extended		F39-JGR3K-L	0.3 m	For emitter, gray
4	Root-Plug Cable for Extended		F39-JGR3K-D	0.3 m	For receiver, black
5	Extended Plug-Socket Cable		F39-JG□B-L	3, 10, 20 m	For emitter, gray
6	Extended Plug-Socket Cable		F39-JG□B-D	3, 10, 20 m	For receiver, black
7	Extended Socket-Straight Cable		F39-JG□A-L	3, 10 m	For emitter, gray
8	Extended Socket-Straight Cable		F39-JG□A-D	3, 10 m	For receiver, black
9	Side-by-side Cascading Cable		F39-JGR12L	12 cm	For emitter and receiver, two cables per set
10	Cascading Cable for Extended		F39-JGR3W	0.3 m	For emitter and receiver, two cables per set
11	Plug-Socket Cable for IO-Link		F39-JG□B-L	3, 10, 20 m	For connection to GX-ILM08C
12	Socket-Straight Cable for IO-Link		XS5F-D521-DJ0-IL	2 m	For connection to NX-ILM400
13	Conversion Cable		F39-JGR3K-SJ	0.3 m	For use of wiring for F3SN, F3SJ-A/-B, or F3SR
			F39-JGR3K-RE	0.3 m	For use of wiring for F3SG-RE
			F39-JGR3K-MS	0.3 m	For use of wiring for MS4800

STEP 4 Choose the optional accessories (sold separately) you need

Intelligent Tap and configuration tool SD Manager 3

Easy monitoring, setting, and IO-Link connection with external devices

Intelligent Tap
F39-SGIT-IL3



Configuration tool for PC
SD Manager 3

Note : Use the SD Manager 3 with the F39-SGIT-IL3 Intelligent Tap.



Bluetooth®
Communication Unit
F39-SGBT



Monitoring tool for smartphones
SD Manager 3 Mobile APP

Requirements
Android 7.0 or higher

For details, refer to your local Omron website.



Reduced wiring system

Simple wiring of light curtains and reset switches

Y-Joint Plug/Socket Connector
F39-GCNY2



Reset Switch Connector
F39-GCNY3

Note : Please prepare a reset switch (NC contact).

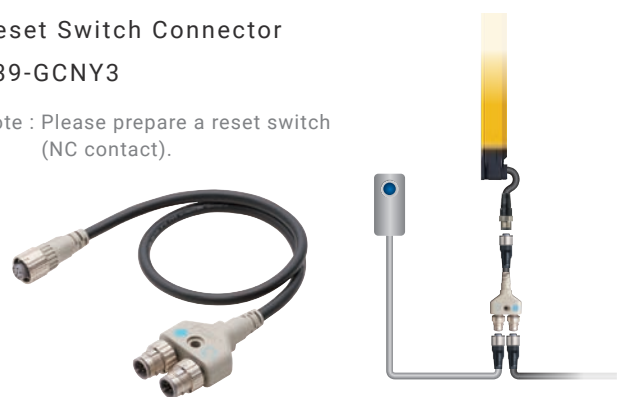

Muting system

Easy installation and wiring of muting sensors

Muting Sensor Arm Mounter
F39-FMA□□□T
(Through-beam)

F39-FMA□□□R
(Retro-reflective)

Muting Sensor Connection Box
F39-GCN5

Muting Sensor Arm Mounter Bracket for SLC
F39-LMAF1
(The E3Z Muting Sensor is sold separately.)

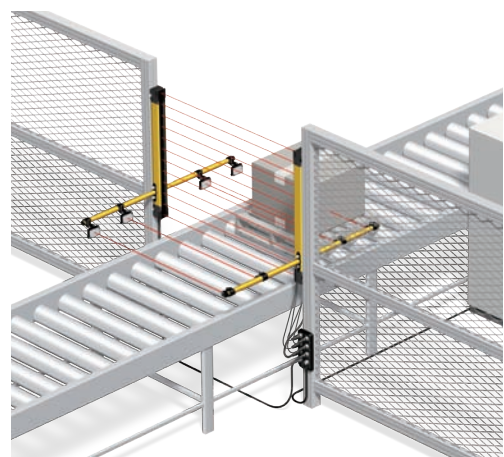

Floor mount system

Easy installation of light curtains and mirrors on floors

Floor Mount Column
F39-ST

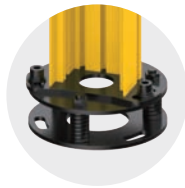

Mount-Column
Adjustable Base
F39-STB

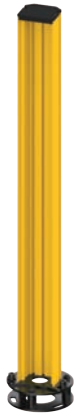

(The Safety light curtain is sold separately.)

Mirror Column
(For F3SG-SR/PG
Safety Light Curtain/
Safety Multi-Light Beam)
F39-SML

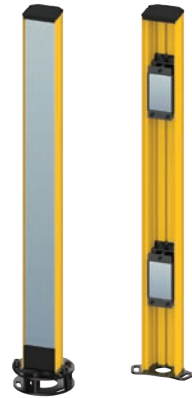

Mirror Column
(for F3SG-PG
Safety Multi-Light Beam)
F39-PML

(The mount-column adjustable base is sold separately.)

Laser Alignment Pointer

Easy beam adjustment with laser beam

F39-PTS



F39-PTG



Lamp

At-a-glance check of light curtain status

F39-SGLP

Note: The Lamp does not support Bluetooth® communication.



Spatter Protection Cover

Protection of optical surfaces against spatter

F39-HSG



Protection in high-pressure wash-down environments

SR Safety Light Curtain
F3SG-SR-K IP69K model

Complete the model number.

F3SG-4SRB □□□□-□□-K
2 1

STEP 1 Choose a safety light curtain Select detection capability and protective height.

1 Select detection capability.

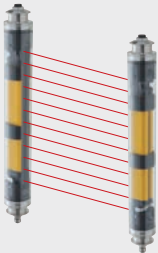
Type	1
 Finger Protection Detection capability 14-mm dia. 	□□ = 14
 Hand Protection Detection capability 25-mm dia. 	□□ = 25

2 Select protective height.

Finger Protection

Protective height (mm)	Number of beams	2
320	31	□□□□ = 0320
400	39	□□□□ = 0400
480	47	□□□□ = 0480
560	55	□□□□ = 0560
640	63	□□□□ = 0640
720	71	□□□□ = 0720
800	79	□□□□ = 0800
880	87	□□□□ = 0880
960	95	□□□□ = 0960
1000	99	□□□□ = 1000
1200	119	□□□□ = 1200
1400	139	□□□□ = 1400
1600	159	□□□□ = 1600
1800	179	□□□□ = 1800

Hand Protection

Protective height (mm)	Number of beams	3
320	16	□□□□ = 0320
400	20	□□□□ = 0400
480	24	□□□□ = 0480
560	28	□□□□ = 0560
640	32	□□□□ = 0640
720	36	□□□□ = 0720
800	40	□□□□ = 0800
880	44	□□□□ = 0880
960	48	□□□□ = 0960
1000	50	□□□□ = 1000
1040	52	□□□□ = 1040
1120	56	□□□□ = 1120
1200	60	□□□□ = 1200
1280	64	□□□□ = 1280
1360	68	□□□□ = 1360
1440	72	□□□□ = 1440
1520	76	□□□□ = 1520
1600	80	□□□□ = 1600
1680	84	□□□□ = 1680
1760	88	□□□□ = 1760
1840	92	□□□□ = 1840

STEP 2 Choose an optional mounting bracket (sold separately)

IP69K Model Mounting Bracket

F39-LSGTB-K

Two brackets per set



For details of mounting brackets, refer to the F3SG-SR/PG Datasheet.

Note: When connecting F3SG-SR-K with open-ended cable to the intelligent tap, use a relay terminal block. Read the User's Manual (Cat .No. Z405) before using the intelligent tap for setting and monitoring.



- STI is a trademark or registered trademark of OMRON Corporation in Japan and other countries.
- The Bluetooth® word mark and logo are registered trademarks and are owned by the Bluetooth SIG, Inc. and any use of such mark by OMRON Corporation is under license.
- Microsoft product screen shot(s) reprinted with permission from Microsoft Corporation.
- Some images are used under license from Shutterstock.com.
- USB Type-C™ is a trademark of USB Implementers Forum.
- Windows® is a registered trademark of Microsoft Corporation in the USA and other countries.
- Android™ is a trademark of Google LLC.
- The product photographs and figures that are used in this catalog may vary somewhat from the actual products.
- Other company names and product names in this document are the trademarks or registered trademarks of their respective companies.

Datasheet

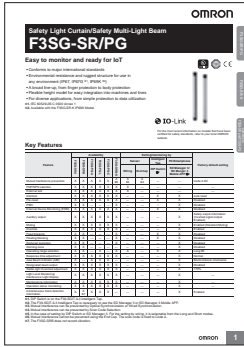

Safety Light Curtain/
Safety Multi-Light Beam
F3SG-SR/PG

Cat. No. F117

Introduction of safety component catalogs



IO-Link Products
IO-Link Series

Cat. No. Y229



Safety Controller
G9SP

Cat. No. F090



Safety Network Controller
NX-Series

Cat. No. F104

Note: Do not use this document to operate the Unit.

OMRON Corporation Industrial Automation Company

Kyoto, JAPAN

Contact : www.ia.omron.com

Regional Headquarters

OMRON EUROPE B.V.

Wegalaan 67-69, 2132 JD Hoofddorp
The Netherlands

Tel: (31) 2356-81-300 Fax: (31) 2356-81-388

OMRON ASIA PACIFIC PTE. LTD.

438B Alexandra Road, #08-01/02 Alexandra
Technopark, Singapore 119968

Tel: (65) 6835-3011 Fax: (65) 6835-2711

OMRON ELECTRONICS LLC

2895 Greenspoint Parkway, Suite 200
Hoffman Estates, IL 60169 U.S.A.

Tel: (1) 847-843-7900 Fax: (1) 847-843-7787

OMRON (CHINA) CO., LTD.

Room 2211, Bank of China Tower,
200 Yin Cheng Zhong Road,
PuDong New Area, Shanghai, 200120, China

Tel: (86) 21-5037-2222 Fax: (86) 21-5037-2200

Authorized Distributor:

©OMRON Corporation 2022 All Rights Reserved.
In the interest of product improvement,
specifications are subject to change without notice.

CSM_1_2

Cat. No. F118-E1-02 0922 (0622)