

Enhanced Systems Using Full-Scale Modules

Systems are easily upgraded using unified key boundary dimensions and a diverse range of options and variations.

F.R.L. combination

"C*000-W"

Consists of air filter, regulator and lubricator.

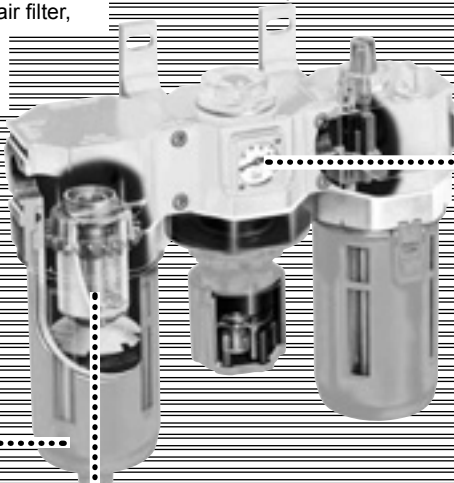

■ Lubricator "L*000-W"
Supplies oil mist to pneumatic lines.

■ Air filter "F*000-W"

Effectively removes dust and water droplets.

■ Regulator
Standard "R*000-W"
Reverse "R*100-W"
Lowers supply pressure to maintain stable set pressure.

Mounting bracket

Page 346

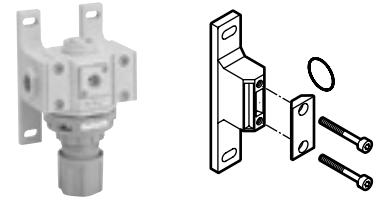

■ T type bracket "B*10-W"
This bracket has two holes on the top and bottom to fix the device to a wall along with upgraded devices.
The 3000-W Series and 4000-W Series can also be connected using B410-W.

Pressure gauge

Page 363



■ Standard integral pressure gauge "G401-W"
Pressure gauge protrusion is reduced.

Filter/regulator



Standard "W*000-W" (page 90)
reverse "W*100-W" (page 98)
The air filter and regulator are integrated to simplify the space-saving assembly.

Oil mist filter

Page 116



"M*000-W" "MX000-W"
Effectively removes oil and oil mist from pneumatic lines.

Residual pressure exhaust valve

Pages 182 to 187



"V*000-W"
The pneumatic line is cut off and residual pressure is released.
For maintenance. Prevents accidents due to residual pressure.
V3010-W with keyhole is also available.

Element For air filter F*000-W and filter regulator W*000-W/W*100-W



■ Standard (5 µm) element "Blank"
This long-life element filters out harmful dirt and foreign matter, etc., from air.



■ Submicron (0.3 µm) element "Y" option
This dedicated element effectively separates tar and carbon. (Non-regenerable)

Bowl, bowl guard and drainage For air filter F*000-W, oil mist filter M*000-W, filter regulator W*000-W/W*100-W

* A bowl guard is installed on the plastic bowl as standard.

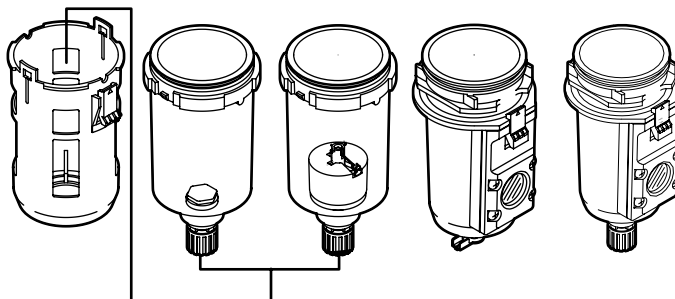

▲ Plastic bowl and bowl guard

▲ Metal bowl

		Bowl			
		Polycarbonate bowl	Nylon bowl	Metal bowl	Metal bowl, man drain cock
Drain discharge	Manual drain cock	Blank (standard)	Z	M	M1
	Auto-drain manual override NO	F	FZ	FM*	FM1
	Auto-drain manual override NC	F1	F1Z	F1M*	F1M1

Refer to page 361 for details on bowl chemical resistance. A metal bowl is not available for the 1000 Series.
The asterisk (*) indicates the metal manual cock with an Rc1/4 port.

- F.R.L.
- F.R.
- F (Filtr)
- R (Reg)
- L (Lub)
- Drain Separ
- Mech Press SW
- Res press exh valve
- SlowStart
- Anti-bac/Bac-remove Filt
- Film Resist FR
- Oil-Prohr
- Med Press FR
- No Cu/PTFE FRL
- Outdrs FRL
- Adapter Joiner
- Press Gauge
- CompFRL
- LgFRL
- PrecsR
- VacF/R
- Clean FR
- ElecPneUR
- AirBoost
- Speed Ctrl
- Silncr
- CheckV/other
- Fit/Tube
- Nozzle
- Air Unit
- PrecsCompn
- Electro Press SW
- ContactSW
- AirSens
- PresSW Cool
- Air Flo Sens/Ctrl
- WaterRiSens
- TotAirSys (Total Air)
- TotAirSys (Gamma)
- Gas generator
- RefrDry
- DesicDry
- HiPolymDry
- MainFiltr
- Dischrg etc
- Ending

* Indicates model No. 1/2/3/4/6/8.
Drawings are simplified here. Refer to individual pages for details.

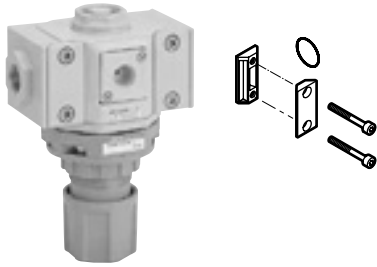

■ Joiner "C*000-J*00-W"
Use this as a fitting when upgrading the system. The 2000-W Series, 3000-W Series and 4000-W Series can also be connected using J400-W.

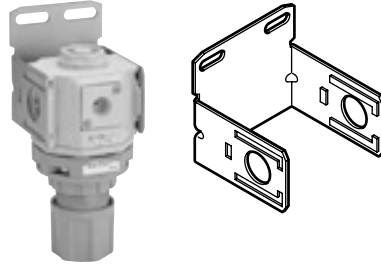

■ C type bracket "B*20"
This bracket fixes single units by simply snapping them in.

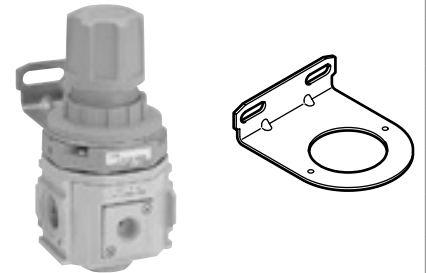

■ L type bracket "B*30"
This bracket fixes parts using the panel mounting nut on the filter regulator or regulator.

For regulator R*000-W/R*100-W and filter regulator W*000-W/W*100-W

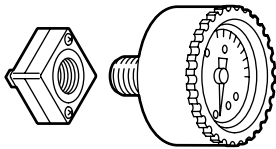

■ Pressure gauge with safety marker "G*OD"
The pressure's actual usage range is displayed with red and green zones making visual control easier.
* This gauge is assembled with the gauge plug.

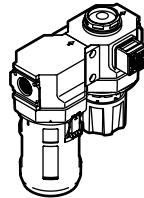

■ Pressure switch with digital display "PPD"
A single unit serves as a pressure detector and indicator, ON/OFF switch, and switch external output.
* Assembly is optional. Option "R1"

Distributor Page 348

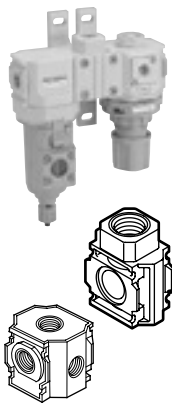

■ One-way branch "D*01-W"
This distributor, which is installed facing either upward or downward, branches pneumatic pressure piping with a large effective sectional area.
■ 4-way branch "D300-W"
The pipe branches in four directions.
* For 3000-W/4000-W Series.

Pipe adaptor Page 350

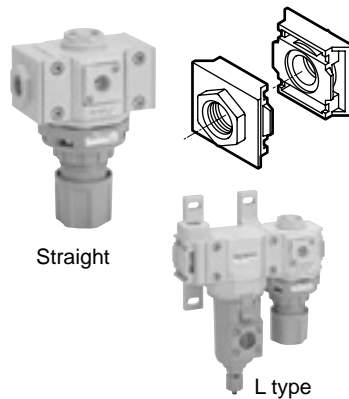

Straight

L type

■ Straight "A*00-W"
By using an adaptor, single units can be removed separately for maintenance instead of removing the piping. The adaptor is convenient for changing the connection port size of single units.
■ L type "A*01-W"
The device's IN and OUT ports are turned by 90° and piped from top or bottom.
* Contact CKD regarding the vertical piping.

Bowl/bowl guard For lubricator L*000-W

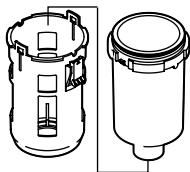

■ Plastic bowl and bowl guard
Material: Polycarbonate - "blank", standard - Nylon "Z" option
* Manual drain cock is "C" option.
* A bowl guard is installed on the plastic bowl as standard.

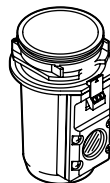

■ Metal bowl
Use the metal bowl in an atmosphere where plastic bowls cannot be used.
Material: Aluminum "M" option
* A metal bowl is not available for the 1000-W Series.

Pressure switch Pages 166 to 178 and 1150

Pneumatic line pressure is repeatedly and accurately checked.



"P4000-W"



"PPR"



"P*100-W"



"PPX"

Contact CKD regarding other system upgrades.

F.R.L.
F.R.
F (Filtr)
R (Reg)
L (Lub)
Drain Separ
Mech Press SW
Res press exh valve
SlowStart
Anti-bac/Bac-remove Filtr
Film Resist FR
Oil-ProhR
Med Press FR
No Cu/ PTFE FRL
Outdrs FRL
Adapter Joiner Press Gauge
CompFRL
LgFRL
PrecsR
VacF/R
Clean FR
ElecPneuR
AirBoost
Speed Ctrl
Silncr
CheckV/ other
Fit/Tube
Nozzle
Air Unit
PresCompn
Electro Press SW
ContactSW
AirSens
PresSW Cool
Air Flo Sens/Ctrl
WaterRISens
TotAirSys (Total Air)
TotAirSys (Gamma)
Gas generator
RefrDry
DesicDry
HiPolymDry
MainFiltr
Dischrg etc
Ending

Oil mist filter

Differential pressure switch option

Element replacement timing is important

The things you risk by not replacing the element at the proper timing...

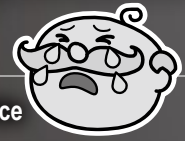

Machining accuracy decrease



Failure/shortened service life of secondary side devices

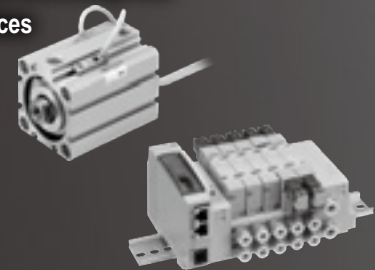

Oil contamination

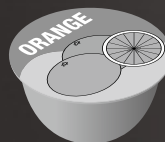

Before this happens, conduct "air predictive maintenance" with a switch and indicator double-check.



Realizing high accuracy predictive maintenance

1 Industry's first* 2-point switch output

The replacement time of the filter is reported in stages, so a higher level of handling and maintenance is possible.



Replacement recommended



Replacement required

It is even possible to confirm the condition of parts of the filter that cannot be seen, enabling remote observation, and it can be installed in the device as well.



Display



Warning lamp

Maintain high precision resistant to failure by providing a fluid passage section to the switch.

2 An indicator that can confirm intuitively

A clear cover and a colorful lamp enables high visibility.

A mark that helps you know when it is time to replace the filter is formed on the clear cover, making handling and maintenance easier.

* As of October 2018, CKD research.

Industry's first*

Switch output
2 points

Highly visible indicator
360°

Patent pending

Switch
IP67

Switch selection available

Choose from 3 types according to application



No switch (differential pressure indicator only)



Differential pressure indicator + SW1





Differential pressure indicator + SW1/SW2

Oil mist filter Differential pressure switch option

in system maintenance.

Use visual inspection and the 2 switches to know the timing of element replacement

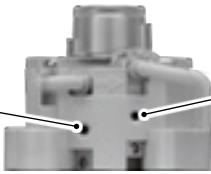
Operation image

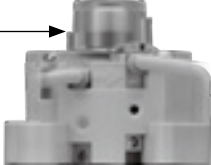
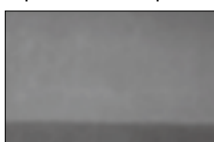
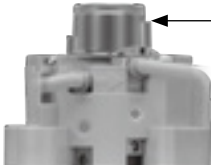
Filter clogging	Indicator (color)	Switch output
Initial (No clogging) 		Caution lamp (SW1): OFF Warning lamp (SW2): OFF
Replacement recommended 	Replacement recommended mark 	Caution lamp (SW1): ON Warning lamp (SW2): OFF
Replacement required 	Replacement required mark 	Caution lamp (SW1): ON Warning lamp (SW2): ON

Usage examples

Laser finishing machine

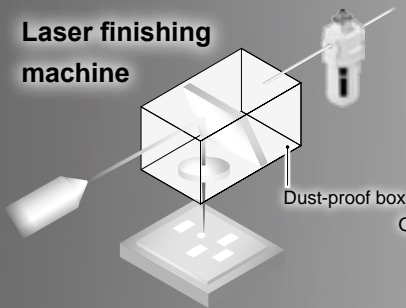

Machine tools

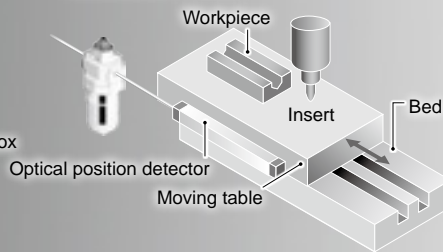

Food processing

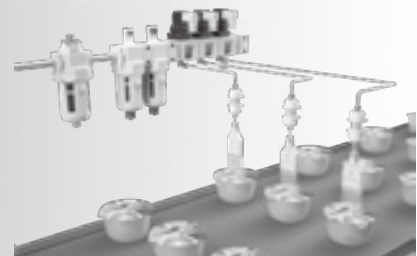

One-Point Predictive Maintenance

Generally speaking, the filter element should be replaced about once a year. This is just a guideline. The amount of oil mist flowing to the secondary side differs according to working conditions.
To keep your system at optimal conditions, replacement needs to be carried out at the appropriate period.

We recommend that you replace your filter elements regularly!



Oil mist filter
**M 2000/3000/
4000/6000 series**

- F.R.L.
- F.R.
- F (Filtr)
- R (Reg)
- L (Lub)
- Drain Separ
- Mech Press SW
- Res press exh valve
- SlowStart
- Anti-bac/Bac-remove Filtr
- Film Resist FR
- Oil-ProhR
- Med Press FR
- No Cu/ PTFE FRL
- Outdrs FRL
- Adapter Joiner
- Press Gauge
- CompFRL
- LgFRL
- PrecsR
- VacF/R
- Clean FR
- ElecPneuR
- AirBoost
- Speed Ctrl
- Silncr
- CheckV/ other
- Fit/Tube
- Nozzle
- Air Unit
- PressCompn
- Electro Press SW
- ContactSW
- AirSens
- PresSW Cool
- Air Flo Sens/Ctrl
- WaterRISens
- TotAirSys (Total Air)
- TotAirSys (Gamma)
- Gas generator
- RefrDry
- DesicDry
- HiPolymDry
- MainFiltr
- Dischrg etc
- Ending

It's a NEW CONCEPT

Pursuing high performance in all aspects: functionality, operability, serviceability and safety.

(Compressed air filter, regulator, lubricator and other components)

F.R.L.
F.R.
F (Filtr)
R (Reg)
L (Lub)
Drain Separ
Mech Press SW
Res press exh valve
SlowStart
Anti-bac/Bac-remove Filtr
Film Resist FR
Oil-ProhR
Med Press FR
No Cu/PTFE FRL
Outdrs FRL
Adapter Joiner Press Gauge
CompFRL
LgFRL
PrecsR
VacF/R
Clean FR
ElecPneur
AirBoost
Speed Ctrl
Silncr
CheckV/other
Fit/Tube
Nozzle
Air Unit
PrecsCompn
Electro Press SW
ContactSW
AirSens
PresSW Cool
Air Flo Sens/Ctrl
WaterRiSens
TotAirSys (Total Air)
TotAirSys (Gamma)
Gas generator
RefrDry
DesicDry
HiPolymDry
MainFiltr
Dischrg etc
Ending

FUNCTIONAL FEATURES

● Compacting/modularization
Main dimensions (width and depth) of F.R.L products have been standardized as compact module. Accurate assembly dimensions are obtained with simple calculations.

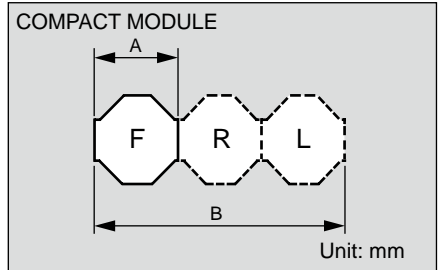

	C1000-W	C2000-W	C2500-W	C3000-W	C4000-W	C6500-W	C8000-W
A	40	50	63	63	63	80	90
B	40×3	50×2+63	63×2+50	63×3	80×3	90×2+100	100×3

● Lightweight (1/2 (CKD comparison))
The hybrid material (body: aluminum die-cast, cover: resin) provides strength, and reduces weight by 50% compared to the conventional type. (C4000 comparison)

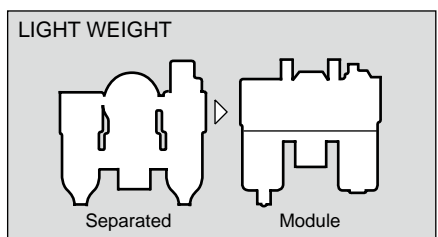

	C1000-W	C2000-W	C2500-W	C3000-W	C4000-W	C6500-W	C8000-W
Module	0.4	1.01	1.01	1.15	1.79	3.64	4.5
Conventional prods	0.7	-	1.8	1.8	3.4	7.2	7.2

● Long service life element
This element incorporates CKD's original chemical fiber structure (patent pending), which has a rough surface and gradually becomes finer toward the interior. Clogging is greatly reduced, and the element life is greatly extended. No need to worry about rust.

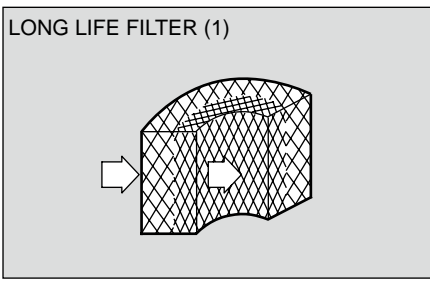

● Embedded pressure gauge for space saving
The conventional protruding pressure gauge wasted space on the front, and caused person(s) to come into contact with it, creating a dangerous situation. A neat design and safety have been realized by embedding the pressure gauge into the body.

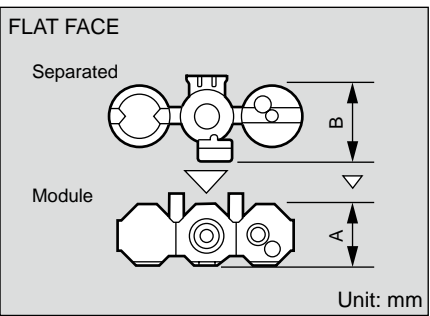

	C1000-W	C2000-W	C2500-W	C3000-W	C4000-W	C6500-W	C8000-W
Module A	57	62	70.5	63	79	100	100
Conventional prods B	74	-	109	109	124	131	131

● Mechanism to prevent oil dripping during primary side pressure drop
Oil dripping caused by reverse flow when pressure is released with the residual pressure exhaust valve, etc., is suppressed.

● Highly corrosion resistant, safe bowl guard
Very safe and corrosion resistant plastic bowl guard is integrated.

● With gauge plug
The gauge plug is sealed even without a pipe plug. (Refer to page 377 when using the screw-in pressure gauge)

⚠ Always read the precautions in the Introduction and on pages 354 to 361 before use.

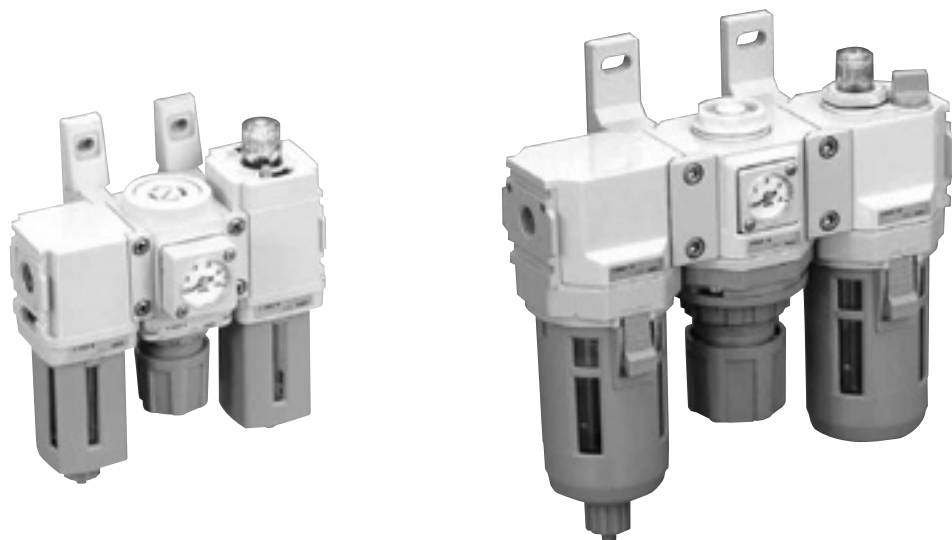

OPERATIVE FEATURES

- **Pressure adjustment without tool**
Pressure can be adjusted with one hand and locking performed with one push. Manual knob operation is easy when setting pressure as well.

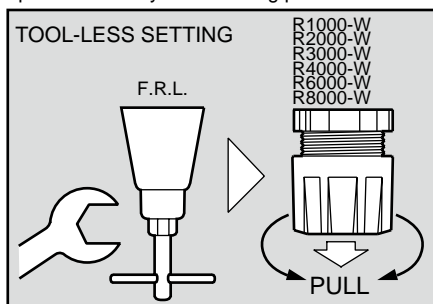

- **Easily handles panel mounting as well**
When the panel mounting nut is loosened, the nut acts as a jack and enables the knob to be removed easily. Fix with a nut when mounting on a panel. The L type bracket is also installed similarly to the nut.

(When mounting with an L type bracket, the body can be fixed securely without play.) * Excluding 8000-W Series.

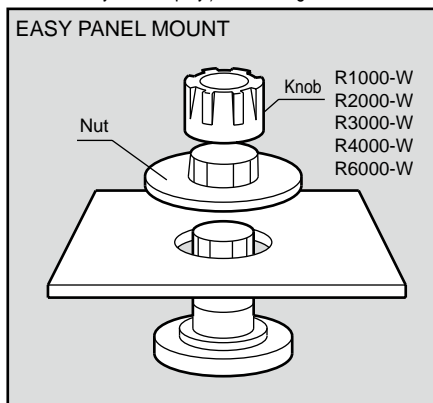

Note: Install the nut before installing the knob. (The nut of R2000-W can be removed without removing the knob.)

- **Oil drip adjustment knob with lock**
Oil dripping is easily adjusted manually without a tool. A stopper is provided in the opening direction to function as a lock, and increase safety. The numbers on the dial are used as a guide after adjusting the dripping.
* Adjust the oil drip to 0.5 N m or less.

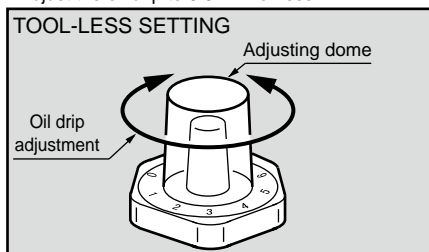

- **Double plastic structure**
A double plastic structure is adopted, so oil dripping can be confirmed from 360°.

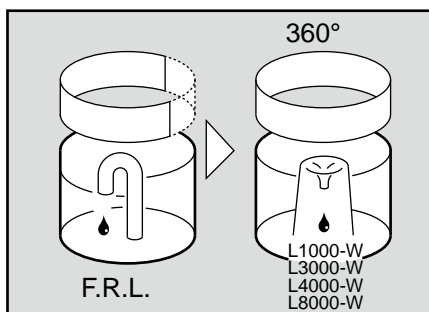

- **One-touch integrated attachment/removal**
The bowl and bowl guard are easily attached/detached together with the quick-release latch. (1000-W Series has no latch)
* Confirm that pressure has been released before mounting or removing the bowl and bowl guard.

- **O-ring position locking**
An O-ring slot is provided on the bowl side to prevent problems caused if the O-ring falls off during bowl attachment and removal.
The O-ring does not fall off during maintenance, and a safe and accurate sealing is attained.

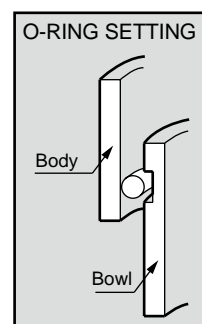

- **One-touch integrated filter element**
The integrated element is removed by turning the baffle 45° to the left. (1000-W Series only)

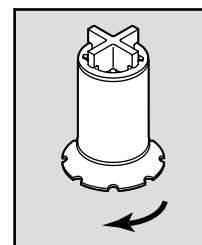

F.R.L.
F.R.
F (Filtr)
R (Reg)
L (Lub)
Drain Separ
Mech Press SW
Res press exh valve
SlowStart
Anti-bac/Bac-remove Filtr
Film Resist FR
Oil-ProhR
Med Press FR
No Cu/ PTFE FRL
Outdrs FRL
Adapter Joiner
Press Gauge
CompFRL
LgFRL
PrecsR
VacF/R
Clean FR
ElecPneuR
AirBoost
Speed Ctrl
Silncr
CheckV/ other
Fit/Tube
Nozzle
Air Unit
PrecsCompn
Electro Press SW
ContactSW
AirSens
PresSW Cool
Air Flo Sens/Ctrl
WaterR/Sens
TotAirSys (Total Air)
TotAirSys (Gamma)
Gas generator
RefrDry
DesicDry
HiPolymDry
MainFiltr
Dischrg etc
Ending

F.R.L. Combination

F.R.L. Option explanation



F.R. Combination lists of drain discharge and bowl material of filter (model No. display Item (D))



Compatible series	Bowl material		Manual drain cock	Auto-drain with manual cock		Large auto-drain with manual cock	
				NO	NC	NO	NC
1000-W Series	Plastic bowl	Polycarbonate	○ (Blank)	×	○ (Code: F1)	×	×
		Nylon	○ (Code: Z)	×	○ (Code: F1Z)	×	×
	Metal bowl	Aluminum	×	×	×	×	×
2*00-W Series	Plastic bowl	Polycarbonate	○ (Blank)	○ (Code: F)	○ (Code: F1)	×	×
3000-W Series		Nylon	○ (Code: Z)	○ (Code: FZ)	○ (Code: F1Z)	×	×
4000-W Series	Metal bowl	Aluminum	○ (Code: M/M1)	○ (Code: FM/FM1)	○ (Code: F1M/F1M1)	×	×
6000-W Series							
8000-W Series	Plastic bowl	Polycarbonate	○ (Blank)	○ (Code: F)	○ (Code: F1)	○ (Code: FF)	○ (Code: FF1)
		Nylon	○ (Code: Z)	○ (Code: FZ)	○ (Code: F1Z)	○ (Code: FFZ)	○ (Code: FF1Z)
	Metal bowl	Aluminum	○ (Code: M/M1)	○ (Code: FM/FM1)	○ (Code: F1M/F1M1)	○ (Code: FFM/FFM1)	○ (Code: FF1M/FF1M1)
Features			-	At night, etc., when there is no pressurization, the valve opens and drainage is discharged automatically.	Air is not purged during initial pressurization.	Hi-Discharge perform, auto-drain discharged when unit has no press.	Discharge performance is high and air is not purged during initial pressurization.

Combination lists of drain discharge and bowl material of lubricator (model No. display Item (D))

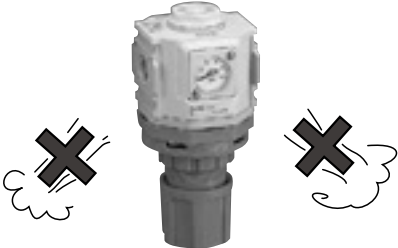
Compatible series	Bowl material		Without manual cock	With manual cock
1000-W Series	Plastic bowl	Polycarbonate	○ (Blank)	○ (Code: C)
		Nylon	○ (Code: Z)	○ (Code: CZ)
	Metal bowl	Aluminum	×	×
2000-W Series 2500-W Series 3000-W Series 4000-W Series 6000-W Series 8000-W Series	Plastic bowl	Polycarbonate	○ (Blank)	○ (Code: C)
		Nylon	○ (Code: Z)	○ (Code: CZ)
	Metal bowl	Aluminum	○ (Code: M)	○ (Code: CM/CM1)

Option and explanation of code with pressure range, relief pressure, pressure gauge, flow direction (model No. display Item (D))

Option code: L	Option code: N	Option code: T
 <ul style="list-style-type: none"> Pressure display: 0 to 0.4 MPa Pressure range: 0 to 0.35 MPa Pressure gauge: G401-W-P04 	 <ul style="list-style-type: none"> Air is not discharged. 	 <ul style="list-style-type: none"> Without pressure gauge The Rc1/4 gauge port is sealed when the plug is mounted. Refer to page 377 when mounting a pressure gauge.

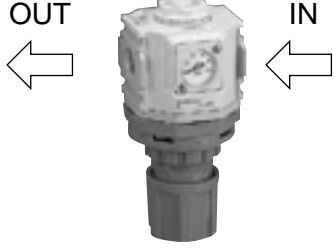
Option code: T8/T6	Option code: RN/RP/R2 (Note)	Option code: X1
 <ul style="list-style-type: none"> A round pressure gauge is included. A pressure gauge is not included. Pressure gauge mounting port is open. Refer to page 377 when mounting a pressure gauge. 	 <ul style="list-style-type: none"> When pressure switch with display PPR is mounted When digital pressure sensor PPX is included (Refer to page 1150 for details.) 	 <ul style="list-style-type: none"> The pressure gauge faces forward, with IN on the right side.

(Note) Option code "RN/RP" is not used for the C*000-W Series or C*010-W Series.

F.R.L. Combination

Operational explanation of float type auto-drain

Operational explanation of float type auto-drain

- NO (F, FF)
3000-W/4000-W/6000-W/8000-W Series

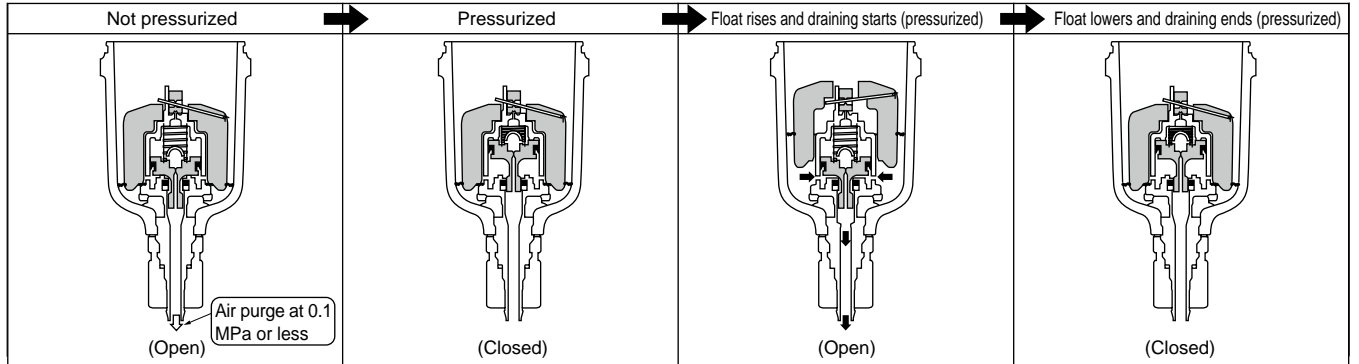

- NC (F1, FF1)
3000-W/4000-W/6000-W/8000-W Series

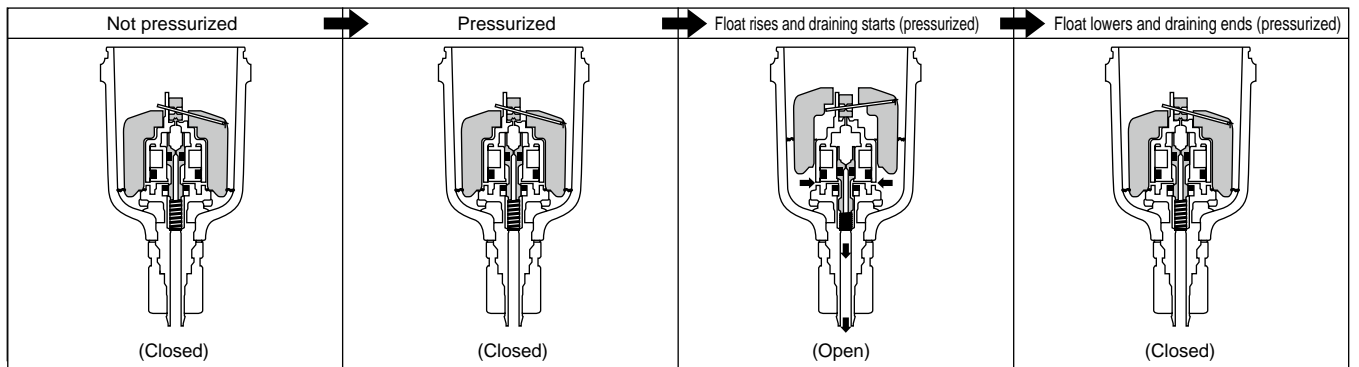

- NC (F1)
1000-W Series

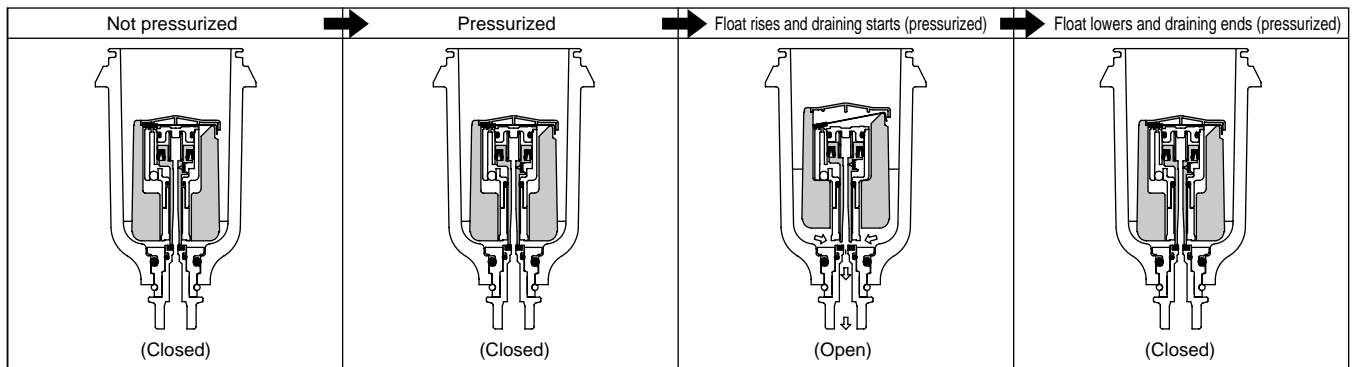

- NC (F1)
2000-W Series

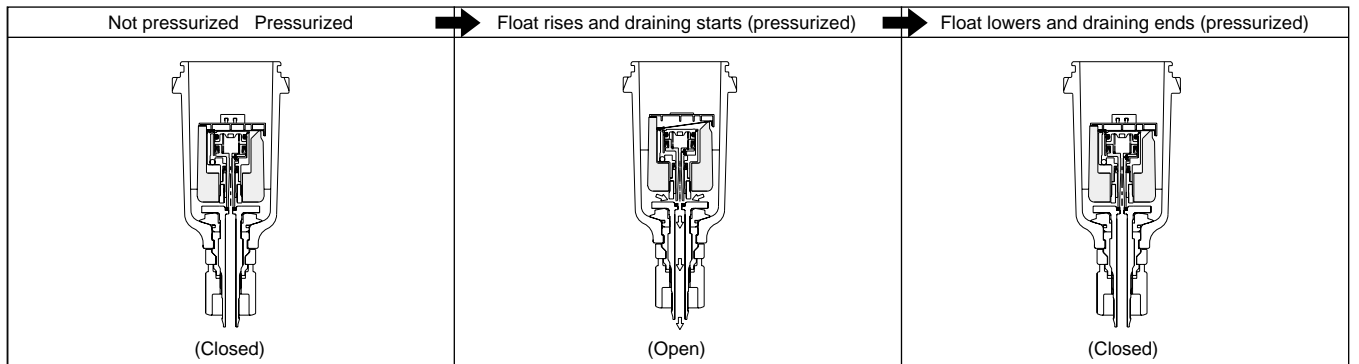

	Operation		Features	Cautions
	Not pressurized (e.g., at night)	Pressurized		
NO	Drain discharge is opened and drainage is discharged naturally.	Drain discharged with drainage discharge section air until press zmin. working press. After filling, drain discharge section is closed.	Drainage is discharged naturally when not pressurized (at night, etc.), so manual discharge is not required. In the pressurized state, once pressure is attained, drainage is automatically discharged when it accumulates at a set level.	As indicated in Features, air and drainage are temporarily discharged until reaching the min. working pressure, so pressure may not be sufficient with a compressor (0.75 kW or less) having a small discharge flow. Use the NC in this case.
NC	The drain discharge section is closed.		Suitable for small discharge compressor (0.75 kW or less). No temporary air purging during pressurization. Once press is maintained, drainage at set level is automatic.	Drainage is not discharged without pressurization (nighttime, etc.), so manual discharge is required in applications where large amounts of drainage are generated in this state.

- F.R.L.
- F.R.
- F (Filtr)
- R (Reg)
- L (Lub)
- Drain Separ
- Mech
- Press SW
- Res press
- exh valve
- SlowStart
- Anti-bac/Bac-remove
- Filter
- Resist FR
- Oil-ProhR
- Med
- Press FR
- No Cu/
- PTFE FRL
- Outdris FRL
- Adapter
- Joiner
- Press
- Gauge
- CompFRL
- LgFRL
- PreclsR
- VacF/R
- Clean FR
- ElecPneuR
- AirBoost
- Speed Ctrl
- Silncr
- CheckV/
- other
- Fit/Tube
- Nozzle
- Air Unit
- PreclsCompn
- Electro
- Press SW
- ContactSW
- AirSens
- PresSW
- Cool
- Air Flo
- Sens/Ctrl
- WaterRISens
- TotAirSys
- (Total Air)
- TotAirSys
- (Gamma)
- Gas
- generator
- RefrDry
- DesiccDry
- HiPolymDry
- MainFiltr
- Dischrg
- etc
- Ending